

## Rhinologie-Instrumentarium

### Rhinology Instruments

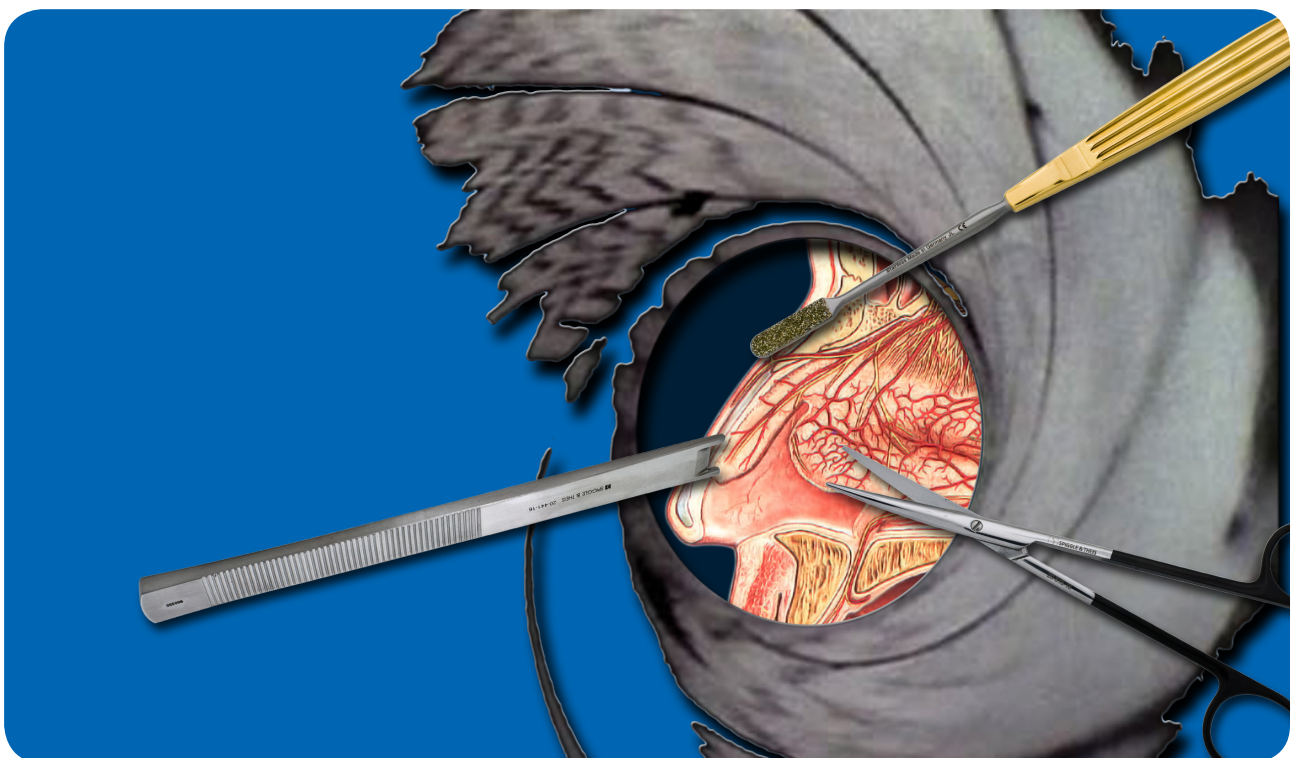





GESCHICHTE

Spiggle & Theis Medizintechnik GmbH wurde 1994 von den Geschäftsführern David Spiggle und Detlef Theis gegründet. Bis heute haben wir uns vom reinen Vertriebsunternehmen zu einem renommierten Hersteller von Medizinprodukten im Bereich der HNO-Chirurgie weiterentwickelt. Zu unseren Kunden in Deutschland zählen mehr als 700 Kliniken und wir exportieren mittlerweile in über 75 Länder weltweit.



HISTORY

Spiggle & Theis Medizintechnik GmbH was founded in 1994 by the managing directors David Spiggle and Detlef Theis. The company evolved from being purely a distributor to the established manufacturer of medical products in the area of ENT that it is today. We can count over 700 clinics amongst our german customers and we export to over 75 countries world wide.

DAS MASS DER DINGE

Im chirurgischen Instrumentenbau gilt das Siegel "MADE IN GERMANY" auch heute noch als Inbegriff von Qualität. Unsere chirurgischen Instrumente werden in allen Produktionsstufen unter strengsten Qualitätsanforderungen in Deutschland produziert, sind also noch echt "MADE IN GERMANY". Zur Verarbeitung wird ausschließlich Instrumentenstahl bester Güte verwendet, welcher den hohen Anforderungen moderner Chirurgie auch dauerhaft gerecht wird.

THE SEAL OF HIGHEST QUALITY

The stamp "MADE IN GERMANY" is still the epitome of quality standards in the production of surgical instruments in the world today. In Germany, our surgical instruments are subjected to the strictest quality requirements at every step of their production, so they are, in the truest sense of the words, "MADE IN GERMANY". Only the highest standard of instrument steel, capable of consistently meeting the demands of modern surgery, is used in the production.

SICHERHEIT ZUERST

Die Gesundheit der Patienten und somit die Sicherheit und Qualität unserer Produkte stehen immer im Mittelpunkt unseres Handelns. In diesem Sinne ist Spiggle & Theis Medizintechnik GmbH bereits seit 1997 ISO-zertifiziert und unsere Produkte nach der strengen europäischen Richtlinie für Medizinprodukte CE-gekennzeichnet. Alle unsere Produkte unterliegen einem permanenten Prozess der Qualitätskontrolle, von der Auswahl des Rohmaterials über die einzelnen Fertigungsschritte bis zum Versand.

SAFETY FIRST

The health of our patients and therefore the safety and quality of our products always plays a central role in our decisions. Spiggle & Theis Medizintechnik GmbH has been ISO certified and our products are CE-marked in accordance with the strict European guidelines for medical products since 1997. All our products undergo continual quality checks, from the selection of raw materials, to the individual stages of production and finally their dispatch.



SERVICE

Unsere Kollegen blicken zum Teil auf mehr als 30 Jahre Berufserfahrung im Umgang mit chirurgischen Instrumenten zurück. Dadurch besitzen wir mehr als theoretisches Wissen – Verständnis für die Bedürfnisse unserer Kunden. Darüber hinaus pflegen wir noch den engen, individuellen Kontakt mit den Anwendern. Dies hilft uns bei der steten, praxisorientierten Weiterentwicklung unserer Produkte. Somit garantieren wir hohe Kompetenz und individuellen Service bei der Betreuung unserer Kunden.

SERVICE

Our colleagues in instrument development can look back on over 30 individual years of professional practical experience with ENT-surgical instruments. We offer more than theoretical knowledge – we understand our customers needs. We enjoy close, personal contact to many of the best surgeons here in Germany. This enables us to continually develop innovative products. We guarantee the highest level of competence and individual service in meeting our customers requirements.





Contents

1	Endoskopie.....	5 - 10
1	Endoscopy.....	5 - 10
2	Nasenspekula.....	11 - 14
2	Nasal Specula.....	11 - 14
3	Untersuchungsinstrumente.....	15 - 19
3	Examination Instruments.....	15 - 19
4	Nasenzangen / Nasenscheren.....	20 - 26
4	Nasal Forceps / Nasal Scissors.....	20 - 26
5	Elevatorien / Raspatorien.....	27 - 29
5	Elevators / Raspatories.....	27 - 29
6	Meißel / Osteotome / Hämmer.....	30 - 35
6	Chisels / Osteotomes / Mallets.....	30 - 35
7	Messer.....	36 - 37
7	Knives.....	36 - 37
8	Wundhaken.....	38 - 41
8	Retractors.....	38 - 41
9	Scheren.....	42 - 49
9	Scissors.....	42 - 49
10	Pinzetten / Nadelhalter.....	50 - 55
10	Forceps / Needle Holders.....	50 - 55
11	Raspeln.....	56 - 59
11	Rasps.....	56 - 59
12	Allgemeines.....	60 - 65
12	Miscellaneous.....	60 - 65
13	Sterilisationssysteme.....	66 - 67
13	Sterilizing Systems.....	66 - 67
14	Sets.....	68 - 71
14	Sets.....	68 - 71
	Index.....	72 - 75
	Index.....	72 - 75
	Umrechnungstabelle.....	76
	Conversation table.....	76



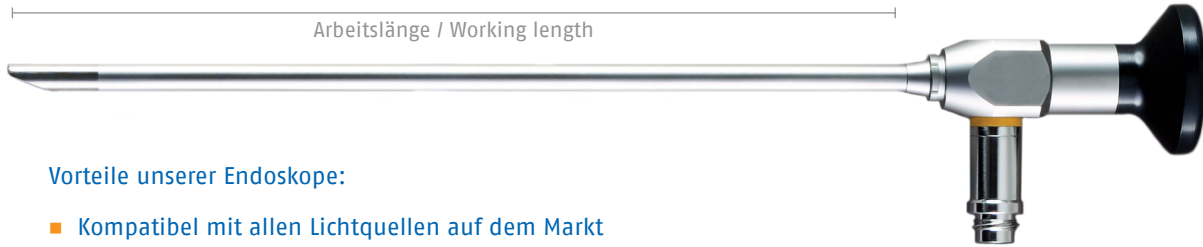

Vorteile unserer Endoskope:

- Kompatibel mit allen Lichtquellen auf dem Markt (universalkompatibel)
- Extrem robuste Rohrkonstruktion mit verstärktem 2-Rohr-Edelstahl-System
- Hochwertig vergütetes, hochauflösendes Linsen-System
- Optische Saphirglas-Frontlinse, kratzfest und hitzebeständig fixiert mit Epoxidharz
- Hitzebeständiges Polymer-Okular (Peek)
- Schnittstellen gelasert = Hohe Dichtigkeit
- Großer Öffnungswinkel = Mehr Bildinformation
- Hohe Bildschärfe im gesamten Bildbereich
- Gleichmäßige Helligkeit bis zum Rand durch Lichtkonus
- Autoklavierbar
- 24 Monate Garantie auf Material- und Produktionsfehler sowie Autoklavierbarkeit
- Semiflex-Modell mit Nitinol-Außenhülle, verbesserter Schutz gegen Verbiegen und Bruch

Auch als semiflex-Endoskope erhältlich  
Also available as semiflex endoscopes

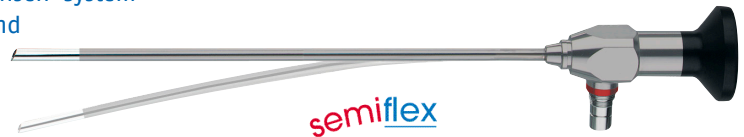

Advantages of our endoscopes:

- Compatible to all light sources available (universal camera compatible)
- Extremely robust stainless steel tube construction with reinforced outer tube
- High precision quality lens system
- Optical sapphire glass front lens, scratch resistant and fixed with heat-resistant epoxide
- Heat-resistant polymer ocular (peek)
- Joints laser welded = tight sealing
- Wide viewing angle = more image information
- High focus quality in entire viewing area
- Constant brightness up to the edge of viewing area
- Autoclavable
- 24 months guarantee against material, production and autoclavability faults
- Semiflex types with nitinol outer tube for improved protection against bending or break

Blickrichtung und Blickwinkel  
Viewing direction and angle

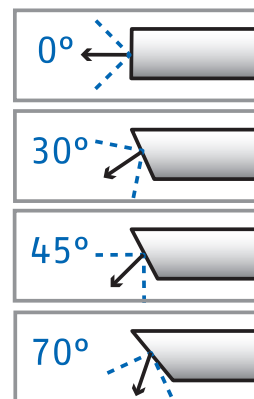





Endoscopy





Sinuskop, HD, semiflex, autoklavierbar, AD 2,7 mm, 18,75 cm **HD**  
Sinuscope, HD, semiflexible, autoclavable, OD 2.7 mm, 18.75 cm

	Winkel / Angle		
30-131-00	0°		30-135-00
30-131-30	30°		30-135-30



Sinuskop universal, HD, semiflex, autoklavierbar, AD 2,7 mm, 11 cm **HD**  
Universal sinuscope, HD, semiflexible, autoclavable, OD 2.7 mm, 11 cm

	Winkel / Angle		
30-135-00	0°		30-135-00
30-135-30	30°		30-135-30



Sinuskop, starr, HD, autoklavierbar, AD 4 mm, 17,5 cm **HD**  
Sinuscope, rigid, HD, autoclavable, OD 4 mm, 17.5 cm

	Winkel / Angle		
30-142-00	0°		30-142-00
30-142-30	30°		30-142-30
30-142-45	45°		30-142-45
30-142-70	70°		30-142-70



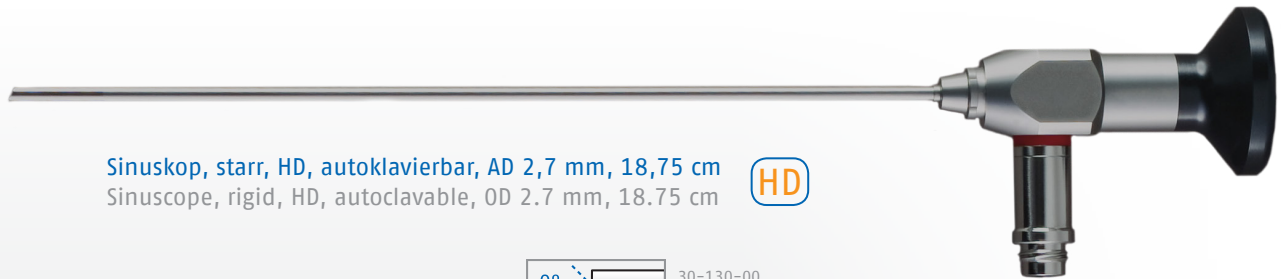

Sinuskop, starr, HD, autoklavierbar, AD 2,7 mm, 18,75 cm  
 Sinuscope, rigid, HD, autoclavable, OD 2.7 mm, 18.75 cm

HD

	Winkel / Angle
30-130-00	0°
30-130-30	30°
30-130-70	70°

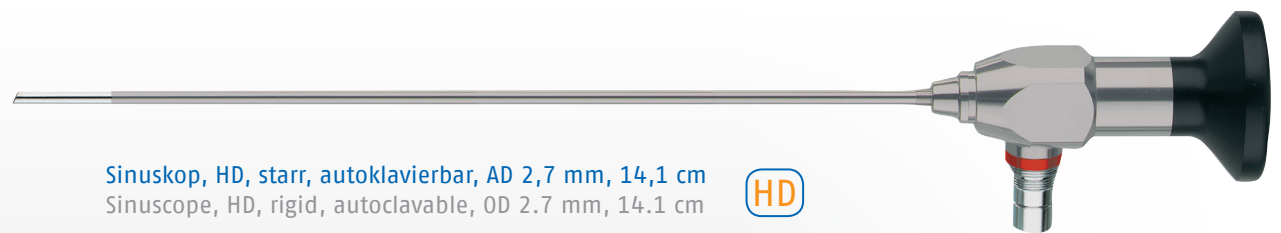
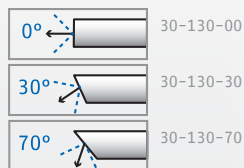

Sinuskop, HD, starr, autoklavierbar, AD 2,7 mm, 14,1 cm  
 Sinuscope, HD, rigid, autoclavable, OD 2.7 mm, 14.1 cm

HD

	Winkel / Angle
30-132-00	0°
30-132-30	30°
30-132-45	45°

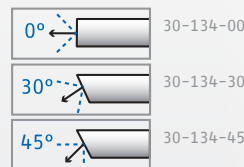

Sinuskop universal, HD, starr, autoklavierbar, AD 2,7 mm, 11 cm  
 Universal sinuscope, HD, rigid, autoclavable, OD 2.7 mm, 11 cm

HD

	Winkel / Angle
30-134-00	0°
30-134-30	30°
30-134-45	45°
30-134-70	70°

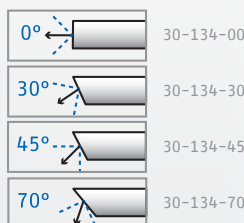



Endoscopy



**Ultra-Stop Antibeschlagmittel**  
Ultra-Stop Anti-Fog solution

- 30-160-01 25 ml Pipettenflasche, unsteril / 25 ml pipette bottle, non-sterile
- 30-160-02 30 ml Durchstichflasche, steril / 30 ml pierce bottle, sterile
- 30-160-03 15 ml Sprayflasche, unsteril / 15 ml spray bottle, non-sterile



**Endoskop-Schutzhülse,**  
20,9 cm, verlängerbar, autoklavierbar, für Endoskop 40-110-xx oder 40-112-xx. (Für 40-112-xx werden 2 Schutzhülsen benötigt)

Endoscope protection sleeve, 20.9 cm, extendable, autoclavable, for endoscope 40-110-xx or 40-112-xx. (Two protection sleeves are needed for 40-112-xx)

30-182-21



**LED-Leuchthandgriffe**  
LED light handles

70-211-00 LED-Hochleistungs-Leuchthandgriff, 230 V, bestehend aus: (70-211-10, 70-211-20, 70-211-30, 70-211-40) / LED high performance light-handle, 230 V, consisting of: (70-211-10, 70-211-20, 70-211-30, 70-211-40)

70-211-01 LED-Hochleistungs-Leuchthandgriff, 120 V, bestehend aus: (70-211-10, 70-211-20, 70-211-30, 70-211-50) / LED high performance light-handle, 120 V, consisting of: (70-211-10, 70-211-20, 70-211-30, 70-211-50)



70-211-10 LED-Handgriff, schwarz, mit Helligkeitsdimmer, Ausschaltautomatik, 3 W, 5500°K, 17500 Lux, zur Verwendung mit Li-Io-Akku 3,5 V und Endoskop-Adapter, 50 Std. Brenndauer / LED light handle, black, with brightness dimmer, automatic switch-off, 3 W, 5500°K, 17500 lux, to use with Li-Io chargeable battery 3.5 V and endoscope adapter, 50 hours run-time

70-211-20 Li-Ionen-Akku, 3,5 V, für LED-Handgriff / Li-ion rechargeable battery, 3.5 V, for LED light-handle

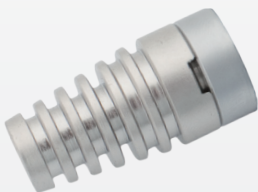

70-211-30 Endoskopie-Adapter für LED-Handgriff, passend für Standardgewinde an Endoskopen (AcMI-Gewinde) / Endoscope adapter for LED light-handle, fits standard endoscope threads (AcMi-thread)

70-211-40 Ladegerät für bis zu 2 LED-Handgriffe, 3,5 V, 230 V, Standgerät, Wandhalterung / Charging base for up to 2 LED light-handles, 3.5 V, 230 V, table model, with wall holder



70-211-50 Ladegerät für bis zu 2 LED-Handgriffe, 3,5 V, 120 V, Standgerät, Wandhalterung / Charging base for up to 2 LED light-handles, 3.5 V, 120 V, table model, with wall holder







<b>Schaftdurchmesser</b> Shaft diameter	<b>3,4 mm</b> 3.4 mm
<b>Arbeitslänge</b> Working length	<b>32 cm</b> 32 cm
<b>Abwinkelung (auf / ab)</b> Angle (up / down)	<b>130°</b> 130°
<b>Biegeradius</b> Bending radius	<b>8 mm</b> 8 mm
<b>Blickfeld</b> Field of vision	<b>80°</b> 80°
<b>Tiefenschärfe</b> Depth of focus	<b>1-50 mm</b> 1-50 mm
<b>Gewicht</b> Weight	<b>230 g</b> 230 g

#### Flexibles Nasopharyngoskop Flexible nasopharyngoscop

30-170-28	2,8 mm	
30-170-36	3,4 mm	
30-171-40	4,0 mm	mit Arbeitskanal / with working channel

Die Spiggle & Theis Nasopharyngoskope der neuen Generation sind intuitiv bedienbar und ergonomisch optimal geformt, entwickelt für die notwendige Feinfühligkeit im täglichen Routineeinsatz und eine ermüdungsfreie Handhabung.

Hochwertige Bildleiter und ein leistungsfähiges optisches System liefern große und helle Bilder bester Auflösung – die Voraussetzung für eine sichere Diagnose und Therapie. Dank solider Verarbeitung und konsequenter Verwendung moderner Hochleistungswerkstoffe sind Spiggle & Theis Nasopharyngoskope robuster und langlebiger – trotz steigender Belastung durch moderne Aufbereitungsverfahren.

The new generation Spiggle & Theis nasopharyngoscopes impress with intuitive operability and optimal ergonomics, designed for tactile sensation and non-tiring handling as required in daily routine operations.

High-end fibre-optic bundles and a high-capacity system produce large and bright images of the best quality – necessary for safe diagnosis and treatment. Due to the consistent use and reliable processing of high-class materials, the Spiggle & Theis nasopharyngoscopes are robust and durable, in spite of the increasing stress of modern cleaning and sterilizing facilities.

- funktionelles Design für eine entspannte, angenehme Handhabung
- feinfühlig, aber robuste Steuerung
- optimale Flexibilität und Torsionssteifigkeit des Einführungsschafts
- leistungsfähiges optisches System: größere, hellere und schärfere Bilder
- geeignete Wiederaufbereitungsverfahren:
  - einlegbar in Reinigungs- und Desinfektionslösung
  - STERIS
  - NTDF-Sterilisation = Niedertemperatur-Dampf-Formaldehyd-Sterilisation
  - maschinelle Aufbereitung (RDG-E)
- functional design for easy and comfortable handling
- sensitive yet robust control
- optimal flexibility and torsional rigidity of the insertion channel
- high-performance optical system for larger, brighter and sharper images
- suitable reprocessing procedures:
  - fully immersible in cleaning and disinfectant solutions
  - STERIS
  - LTSF-sterilization = Low-Temperature Steam and Formaldehyde-sterilization
  - machine reprocessing (RDG-E)



Endoscopy



Dichtigkeitstester für flexible Endoskope  
Leak tester for flexible endoscopes

30-169-08





**Hartmann Nasenspekulum, zerlegbar**  
Hartmann nasal speculum, dismantlable

- 20-100-01 für Erwachsene / for adults
- 20-100-02 für Jugendliche und Kinder / for juveniles and children



**Tieck-Halle Nasenspekulum, zerlegbar, 13 cm**  
Tieck-Halle nasal speculum, detachable, 13 cm

- 20-101-00 2,10 cm für Kinder / for children
- 20-101-01 1,75 cm für Säuglinge / for newborn



**Hartmann-Halle Nasenspekulum, flaches Blatt, zerlegbar**  
Hartmann-Halle nasal speculum, flat blade, dismantlable

- 20-110-01 1 für Kinder / for children
- 20-110-02 2 für Jugendliche / for juveniles
- 20-110-03 3 für Erwachsene / for adults



**Hartmann Nasenspekulum, zerlegbar, 15 cm**  
Hartmann nasal speculum, dismantlable, 15 cm

- 20-112-01 1 2,7 cm
- 20-112-02 2 3,0 cm
- 20-112-03 3 3,4 cm



Den Größenvergleich der Blätter von Nasenspekula finden Sie auf Seite 77 / Please see page 77 for a comparison of sizes of specula blades





Nasal Specula



**Beckmann Nasenspekulum, seitlich gebogen**  
Beckmann nasal speculum, curved to side

20-115-00



**Killian Septum-Spekulum, 14 cm**  
Killian septum speculum, 14 cm

20-148-40 4,0 cm  
20-148-55 5,5 cm  
20-148-75 7,5 cm  
20-148-90 9,0 cm



**Cottle Septum-Spekulum, 50 mm**  
Cottle septum speculum, 50 mm

20-149-55

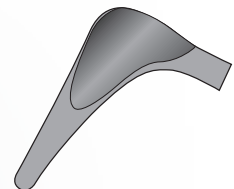

**Killian-Struycken Septum-Spekulum**  
Killian-Struycken septum speculum

20-150-40 4,0 cm  
20-150-55 5,5 cm  
20-150-75 7,5 cm  
20-150-90 9,0 cm

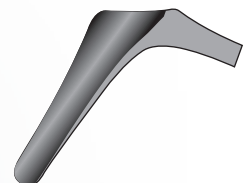

Den Größenvergleich der Blätter von Nasenspekula finden Sie auf Seite 77 / Please see page 77 for a comparison of sizes of specula blades



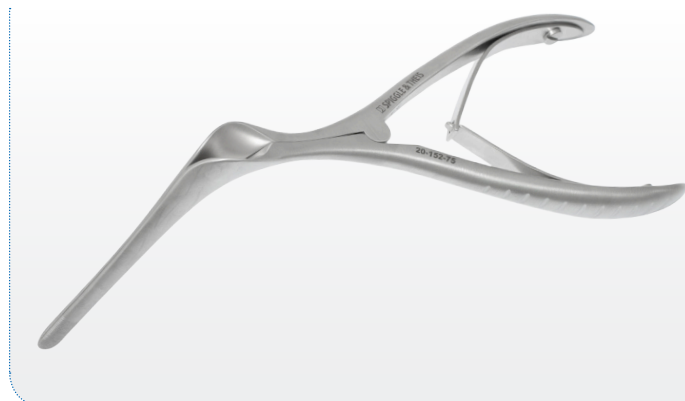

**Herberhold Septum-Spekulum, extra fein, geriefte Außenfläche**  
Herberhold septum speculum, extra fine, serrated blades

- 20-152-40 3,5 cm
- 20-152-55 5,5 cm
- 20-152-75 7,5 cm
- 20-152-90 9,0 cm
- 20-147-55 5,5 cm



mit Stellschraube / with setting screw



**Cottle Septum-Spekulum mit Stellschraube**  
Cottle septum speculum with setting screw

- 20-151-40 3,5 cm
- 20-151-55 5,5 cm
- 20-151-75 7,5 cm
- 20-151-90 9,0 cm

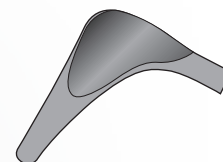

**Cottle Septum-Spekulum, schwarz, extra dünne Blätter, mit Stellschraube**  
Cottle septum speculum, black, very thin blades, with setting screw

- 20-153-40 3,5 cm
- 20-153-45 4,7 cm
- 20-153-55 5,7 cm
- 20-153-75 7,5 cm

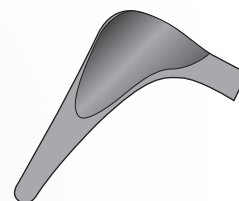

**Killian Septum-Spekulum mit Lichtträger, 14 cm**  
Kilian septum speculum with fibre light carrier, 14 cm

- 20-155-40 4,0 cm
- 20-155-55 5,5 cm
- 20-155-75 7,5 cm
- 20-155-90 9,0 cm
- 20-155-00 Lichtträger allein / fibre light carrier

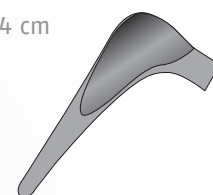

Den Größenvergleich der Blätter von Nasenspekula finden Sie auf Seite 77 / Please see page 77 for a comparison of sizes of specula blades

## Nasal Specula



**Cottle selbsthaltendes Septum-Spekulum für flexiblen Spannarm, mit Stellschraube**  
Cottle self-holding septum speculum for flexible holding arm, with setting screw

20-156-40	4,0 cm
20-156-55	5,5 cm
20-156-75	7,5 cm
20-156-90	9,0 cm



**Selbsthaltendes Spekulum mit Stellschraube, rechts und links gezahnt**  
Self-holding speculum with setting screw, teeth left and right

30-711-00

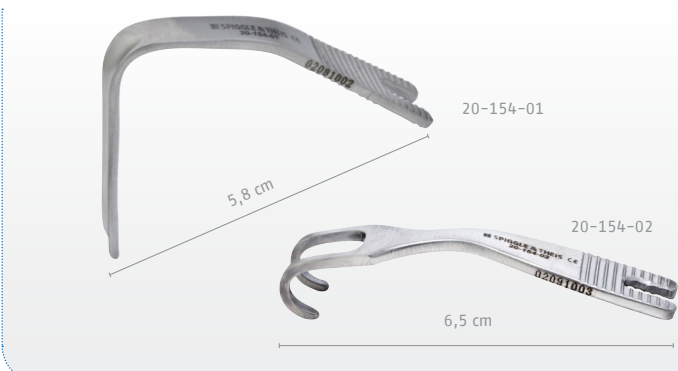

**Aufrecht Haken für flexiblen Spannarm**  
Aufrecht retractor for flexible holding arm

20-154-01	einfach / simple
20-154-02	zwei Zähne / two teeth

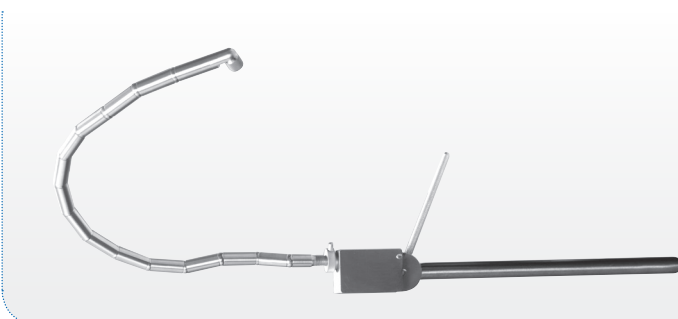

**Flexibler Spannarm für selbsthaltende Spekula, Haken, Ohrtrichterhalter und Endoskophalter, mit Verlängerungsstange**  
Flexible holding arm for self-retaining specula, hooks, ear specula and endoscope holders, with extension rod

30-700-00

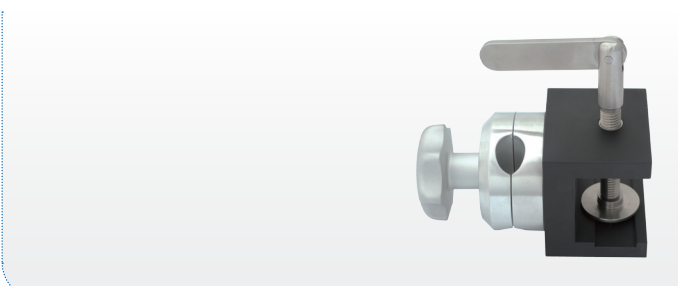

**Gelenkkloben zur Befestigung am OP-Tisch, passend für flexiblen Spannarm 30-700-00 und Narkosebügel 40-337-00**

Rotation clamp for fixation to operating table, compatible with flexible holding arm 30-700-00 and anesthesia frame 40-337-00

30-700-01

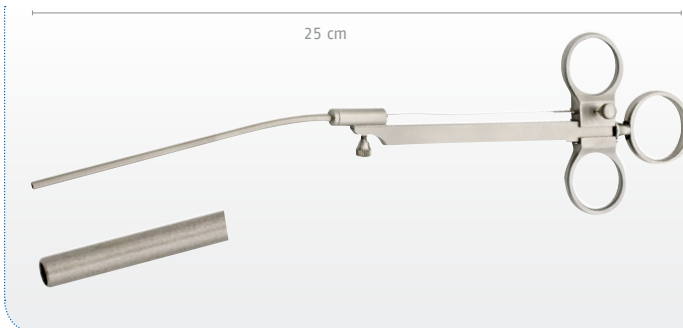

**Krause Nasen-Polypen-Schnürer,  
scharf, 25 cm**  
Krause nasal polyp snare, sharp, 25 cm

20-190-25

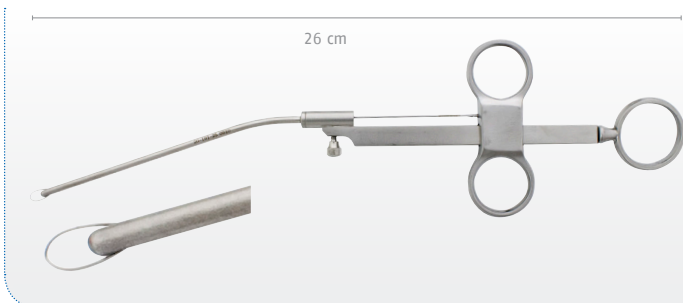

**Krause-Voss Nasen-Polypen-Schnürer,  
stumpf, 26 cm**  
Krause-Voss nasal polyp snare,  
blunt, 26 cm

20-191-25

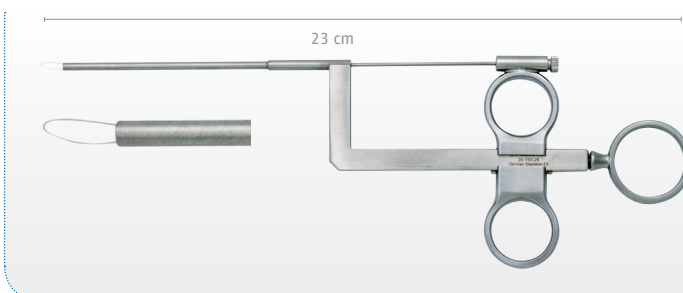

**Lange Nasen-Polypen-Schnürer,  
bajonett, scharf, 23 cm**  
Lange nasal polyp snare,  
bayonet, sharp, 23 cm

20-193-25



**Nasenpolypenschlingen,  
0,35 mm, 12 cm, 100 Stück**  
Nasal polyp snare wires,  
0.35 mm, 12 cm, 100 pieces

20-195-35

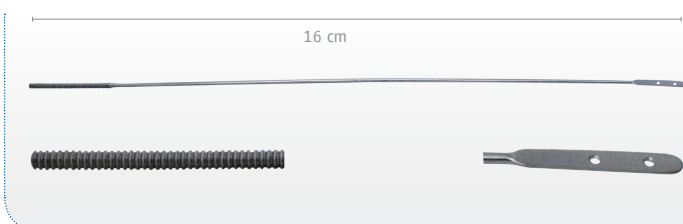

**Ziehstange für Nasen-Polypen-Schnürer**  
Styilet for nasal polyp snares

20-191-00



Examination Instruments



**Hartmann Nasentamponadezange**  
Hartmann nasal sponge holding forceps

20-200-16 16 cm, fein / fine  
20-202-20 20 cm

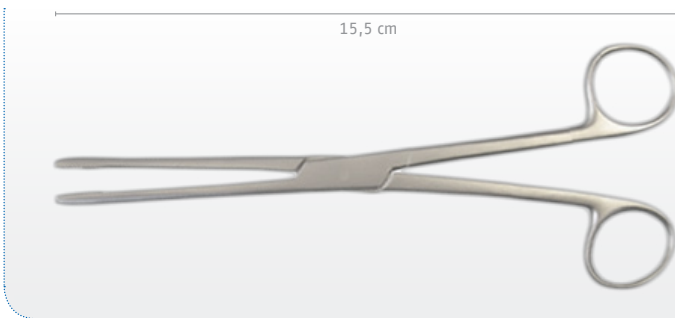

**Lister Nasentamponadezange, gerade, 15,5 cm**  
Lister nasal sponge holding forceps, straight, 15.5 cm

20-205-16



**Westmacott Nasentamponadezange, schmal, 20 cm**  
Westmacott nasal sponge holding forceps, slender, 20 cm

20-207-20



**Noyes Nasentamponadezange, fein gerieft, 13 cm**  
Noyes nasal sponge holding forceps, fine serrated, 13 cm

20-208-20







**Kabierske Pulverbläser, komplett mit drei Kanülen für Ohr, Nase, Rachen und Hals, mit Glas und Ventilball**  
 Kabierske powder blower, set with three cannulae for ear, nose, pharynx and larynx, bottle and rubber ball

- 10-155-00 Pulverbläser komplett / powder blower, set
- 10-155-01 Ersatzglas / spare bottle
- 10-155-02 Gummiball / rubber ball



**Kabierske Kanüle, gerade**  
 Kabierske cannula, straight

- 10-155-08 8 cm
- 10-155-11 11 cm



**Kabierske Kanüle, gebogen, 13 cm**  
 Kabierske cannula, curved, 13 cm

10-155-13

## Examination Instruments



Abbildung ähnlich / similar to illustration

**Glatzel Nasenspiegel,**  
hochglänzend, 20 x 13 cm  
Glatzel nasal mirror,  
high gloss, 20 x 13 cm

20-198-00

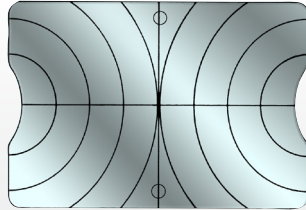
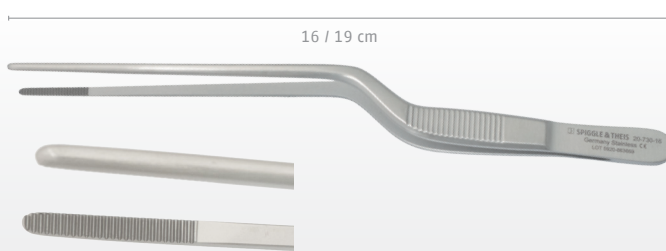

**Jansen Nasenpinzette,**  
bajonett, anatomisch  
Jansen nasal forceps,  
bayonet, anatomical

20-730-16 16 cm  
20-730-19 19 cm

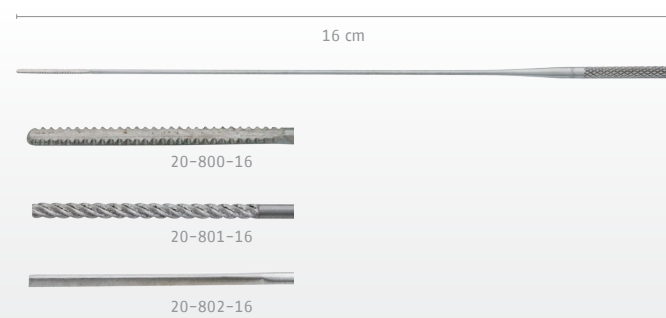

**Watteträger,**  
ø 1,2 mm, 16 cm, 5 Stück  
Cotton carrier,  
ø 1.2 mm, 16 cm, 5 pieces

20-800-16 dreikant, gerieft / triangular, serrated  
20-801-16 rund, gerieft / round, serrated  
20-802-16 dreikant, glatt / triangular, smooth



**Saugrohr mit abgeflachtem Ende,**  
ø 5 mm, 15,5 cm  
Suction tube with flattened end,  
ø 5 mm, 15.5 cm

20-199-05



**Saugrohr, kniegebogen, zylindrisch**  
Suction tube, angled, cylindrical

	AD / OD	Länge / Length
10-300-10	1,0 mm	9 cm
10-300-15	1,5 mm	9 cm
10-300-20	2,0 mm	9 cm
10-300-25	2,5 mm	11 cm
10-300-30	3,0 mm	11 cm
10-300-40	4,0 mm	11 cm
10-300-50	5,0 mm	11 cm



**Saugrohr, kniegebogen, konisch**  
Suction tube, angled, conical

	AD / OD	Länge / Length
10-302-30	3,0 mm	11,5 cm
10-302-35	3,5 mm	11,5 cm
10-302-45	4,5 mm	13,5 cm



**Saugrohr, gerade, biegsam, konisch, AD 3,0 mm, 17,5 cm**  
Suction tube, straight, bendable, conical, OD 3.0 mm, 17.5 cm

10-303-18

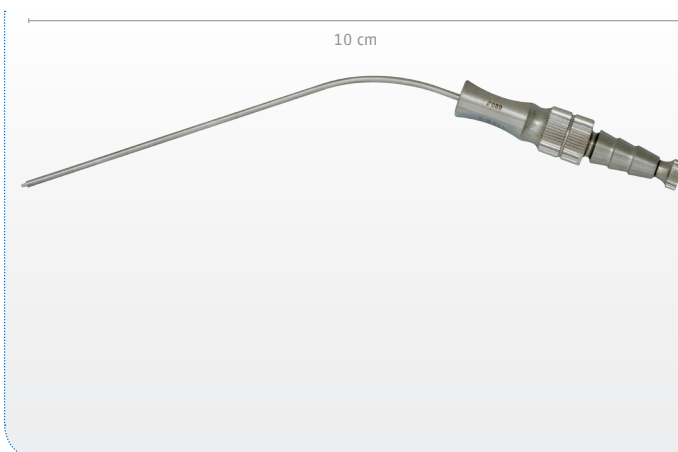

**Frazier Saugrohr, mit Griffplatte und Unterbrecher, 10 cm**  
Frazier suction tube, with suction interruptor, 10 cm

	AD / OD	
30-103-06	6 Ch/Fr	(= 2,0 mm)
30-103-07	7 Ch/Fr	(= 2,3 mm)
30-103-08	8 Ch/Fr	(= 2,7 mm)
30-103-09	9 Ch/Fr	(= 3,0 mm)
30-103-10	10 Ch/Fr	(= 3,3 mm)
30-103-12	12 Ch/Fr	(= 4,0 mm)
30-103-15	15 Ch/Fr	(= 5,0 mm)

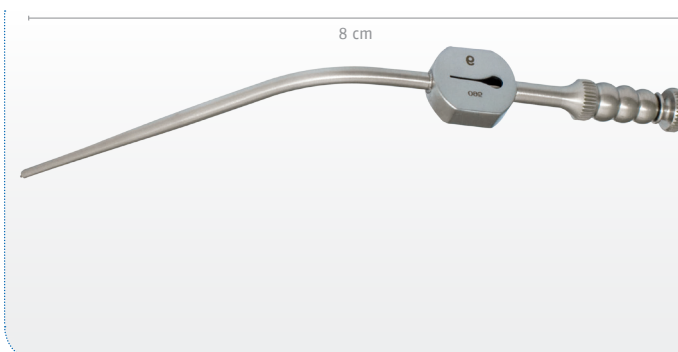

**Frazier Saugrohr, konisch, mit tränenförmiger Saugsteuerung, 8 cm**  
Frazier suction tube, conical, with tearform suction control, 8 cm

	AD / OD	
30-105-06	6 Ch/Fr	(= 2,0 mm)
30-105-08	8 Ch/Fr	(= 2,7 mm)
30-105-10	10 Ch/Fr	(= 3,3 mm)

Nasal Forceps / Nasal Scissors

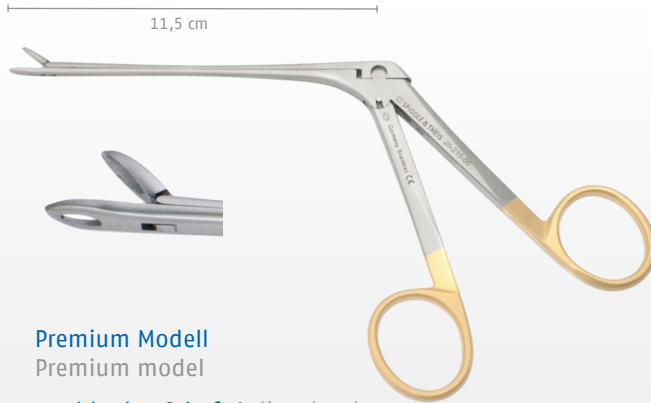





**Premium Modell**  
Premium model

- schlanker Schaft / slim shank
- schmales Maulteil / slender jaw
- besonders feine Ausarbeitung / smooth finish

**Blakesley Nasenzange Premium, gerade, 11,5 cm**  
Blakesley premium nasal forceps, straight, 11.5 cm

Größe / Size

20-215-00	3,0 mm	
20-215-01	3,5 mm	
20-215-02	4,0 mm	
20-215-03	5,0 mm	
20-215-04	6,0 mm	

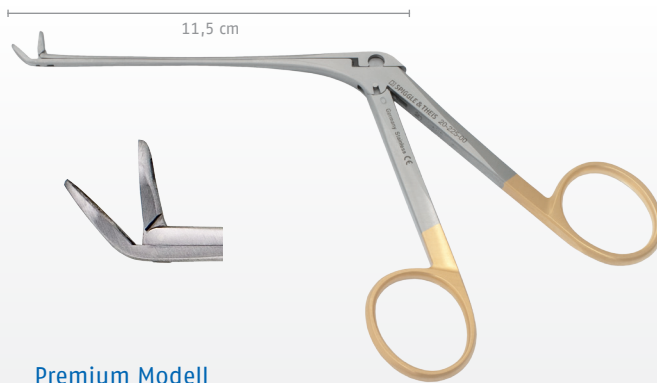





**Premium Modell**  
Premium model

- schlanker Schaft / slim shank
- schmales Maulteil / slender jaw
- besonders feine Ausarbeitung / smooth finish

**Blakesley Nasenzange Premium, 45° aufgebogen, 11,5 cm**  
Blakesley premium nasal forceps, 45° upcurved, 11.5 cm

Größe / Size

20-225-00	3,0 mm	
20-225-01	3,5 mm	
20-225-02	4,0 mm	
20-225-03	5,0 mm	
20-225-04	6,0 mm	

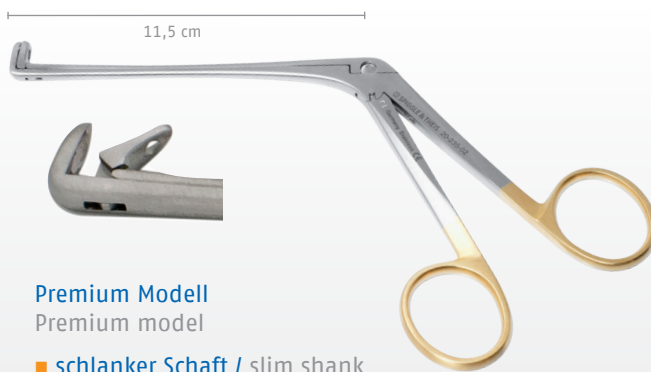



**Premium Modell**  
Premium model

- schlanker Schaft / slim shank
- schmales Maulteil / slender jaw
- besonders feine Ausarbeitung / smooth finish

**Blakesley Nasenzange Premium, 90° aufgebogen, 11,5 cm**  
Blakesley premium nasal forceps, 90° upcurved, 11.5 cm

Größe / Size

20-235-01	3,5 mm	
20-235-02	4,0 mm	
20-235-03	5,0 mm	



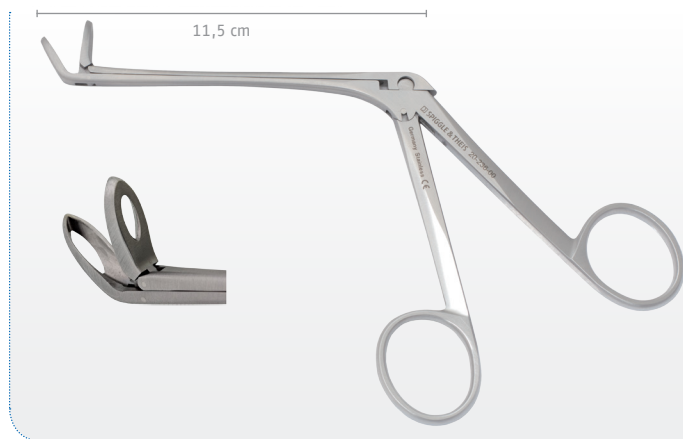

**Wigand Polypen-Fasszange, 60° aufgebogen, 11,5 cm**  
Wigand polyp-grasping forceps, 60° upcurved, 11.5 cm

20-236-00



**Strümpel-Voss Nasenzange, 45° aufgebogen, 11,5 cm**  
Strümpel-Voss nasal forceps, 45° upcurved, 11.5 cm

20-238-00

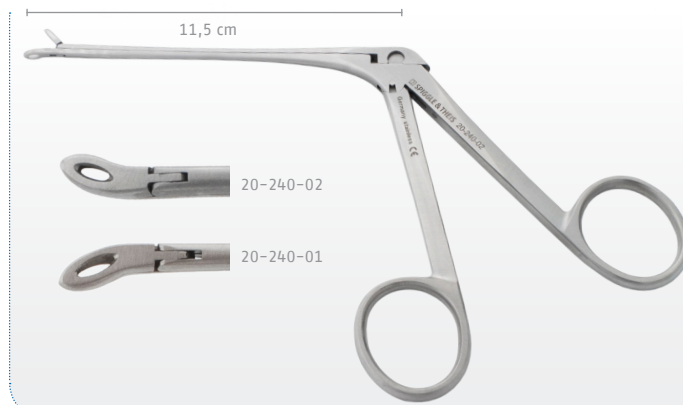



**Blakesley Nasenzange, 11,5 cm**  
Blakesley nasal forceps, 11.5 cm

20-240-01 links gebogen / left curved  
20-240-02 rechts gebogen / right curved



**Takahashi Nasenzange, gerade**  
Takahashi nasal forceps, straight

20-245-01 11,5 cm ø 2,5 mm   
20-245-11 15,0 cm ø 2,5 mm   
20-246-01 11,5 cm ø 4,0 mm 

Nasal Forceps / Nasal Scissors

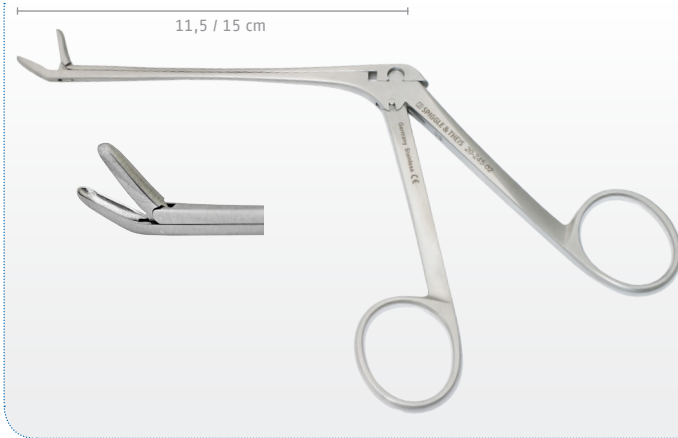

**Takahashi Nasenzange,  
30° aufgebogen**  
Takahashi nasal forceps,  
30° upcurved

20-245-02	11,5 cm	∅ 2,5 mm	
20-245-12	15,0 cm	∅ 2,5 mm	
20-246-02	11,5 cm	∅ 4,0 mm	



**Watson-Wiliams Nasenzange,  
gerade, gezahnt 11,5 cm**  
Watson-Wiliams nasal forceps,  
straight, serrated, 11.5 cm

20-248-00



**Ferris-Smith Nasenzange,  
querverieft, mit Loch, 11,5 cm**  
Ferris-Smith nasal forceps,  
serrated, with hole, 11.5 cm

20-249-00





**Craig Septum-Zange,  
scharfe Löffel, gerade, 10 cm**  
Craig septum forceps,  
sharp cups, straight, 10 cm

20-258-00



**Craig-Domnick Septum-Zange,  
scharfe Löffel, links gebogen, 10 cm**  
Craig-Domnick septum forceps,  
sharp cups, left curved, 10 cm

20-259-00



**Kazanjian Knochenzange,  
gerade, 19 cm**  
Kazanjian rongeur,  
straight, 19 cm

20-270-19



**Rowland Nasenzange,  
Doppelgelenk, gerade, 14,5 cm**  
Rowland rongeur,  
double joint, straight, 14.5 cm

20-274-18



Nasal Forceps / Nasal Scissors



**Caplan Nasenschere,  
Doppelgelenk, gebogen, 20,5 cm**  
Caplan nasal scissors,  
double joint, angled, 20,5 cm

20-272-21



**Struycken Nasenzange,  
durchschneidend, gerade, 1,0 mm,  
11,5 cm Arbeitslänge**  
Struycken nasal forceps,  
throughcutting, straight, 1.0 mm,  
11.5 cm working length

20-250-00



**Hartmann Conchotom,  
rund, 12 cm**  
Hartmann cutting forceps,  
round, 12 cm

Größe / Size

20-252-01 1 = 7 mm

20-252-02 2 = 8 mm

20-252-03 3 = 9 mm

20-252-04 4 = 10 mm







**Schmeden Conchotom, dreieckig, 12 cm**  
Schmeden cutting forceps, triangular, 12 cm

	Größe / Size	
20-254-00	0 = 6 mm	
20-254-01	1 = 7 mm	
20-254-02	2 = 8 mm	
20-254-03	3 = 12 mm	

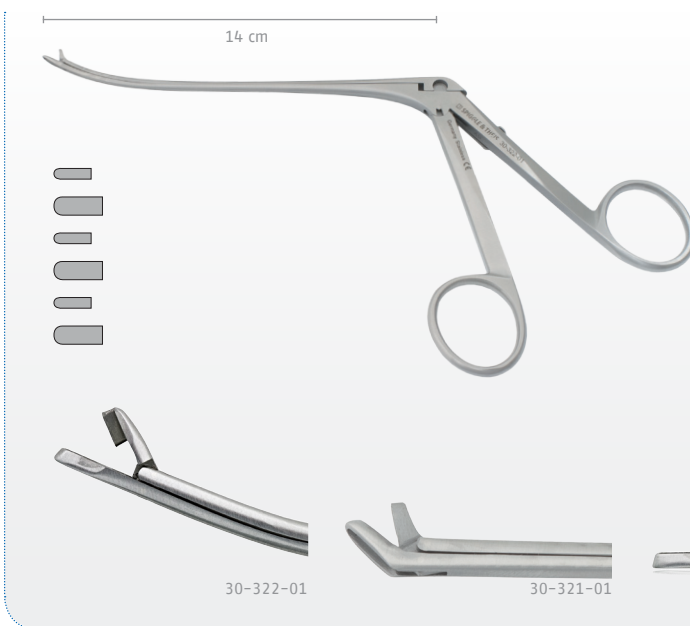

**Durchschneidende Nasenzange, 14 cm**  
Throughcutting nasal forceps, 14 cm

	Größe / Size	
30-320-01	gerade / straight	5,0 x 1,5 mm
30-320-02	gerade / straight	6,5 x 2,5 mm
30-321-01	60° gewinkelt / 60° angled	5,0 x 1,5 mm
30-321-02	60° gewinkelt / 60° angled	6,5 x 2,5 mm
30-322-01	aufgebogen / upcurved	5,0 x 1,5 mm
30-322-02	aufgebogen / upcurved	6,5 x 2,5 mm

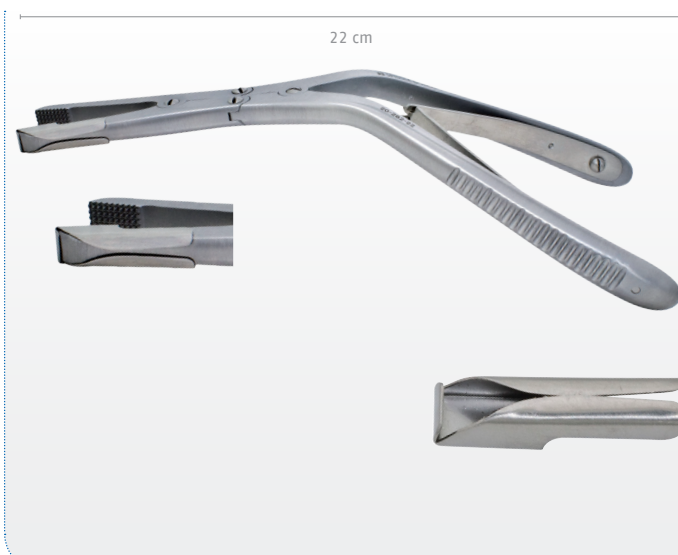

**Rubin Knorpelquetschzange, Doppelgelenk, gebogen, 22 cm**  
Rubin morcelizer forceps, double joint, curved, 22 cm

20-282-22

**Schutzhülse für Rubin Knorpelquetschzange 20-282-22**  
Sleeve for Rubin morcelizer forceps 20-282-22

20-282-99



Nasal Forceps / Nasal Scissors



**Kressner Muschelquetschzange,  
gebogen, 3 mm, 22 cm**  
Kressner turbinate crushing forceps,  
curved, 3 mm, 22 cm

20-280-21

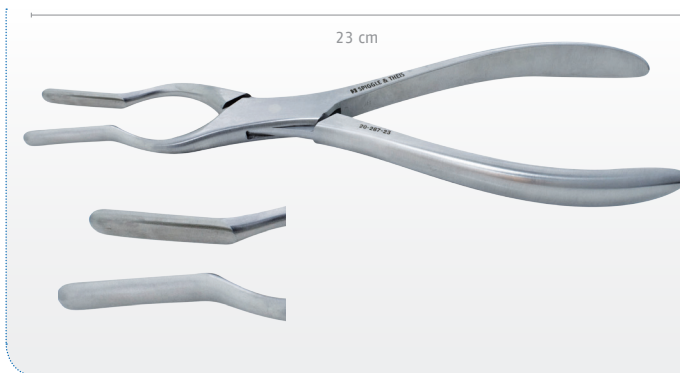

**Cottle-Walsham Septum-Richtzange,  
gerade, 23 cm**  
Cottle-Walsham septum straightening forceps,  
straight, 23 cm

20-287-23



**Ash Septum-Richtzange,  
gebogen, 22 cm**  
Ash septum straightening forceps,  
curved, 22 cm

20-290-22





**Masing Elevatorium/Raspatorium, 21 cm**  
Masing elevator/raspatory, 21 cm

20-300-21



**Cottle Elevatorium/Raspatorium, 23 cm**  
Cottle elevator/raspatory, 23 cm

20-301-23



**Freer Doppelevatorium, scharf/stumpf**  
Freer elevator, double ended, sharp/blunt

20-305-18 18 cm  
20-306-20 20 cm

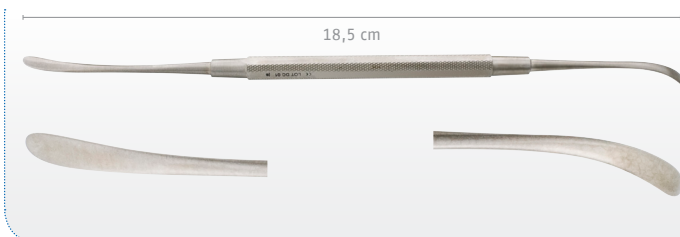

**Weber Doppelevatorium, scharf/stumpf, 18,5 cm**  
Weber elevator, double ended, sharp/blunt, 18.5 cm

20-307-18

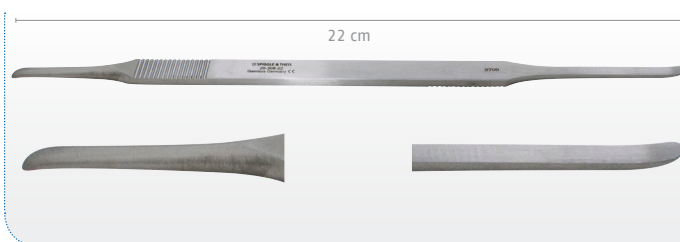

**McKenty Doppelraspatorium, leicht/stark gebogen, 22 cm**  
McKenty raspatory, double ended, slightly/strongly curved, 22 cm

20-308-22

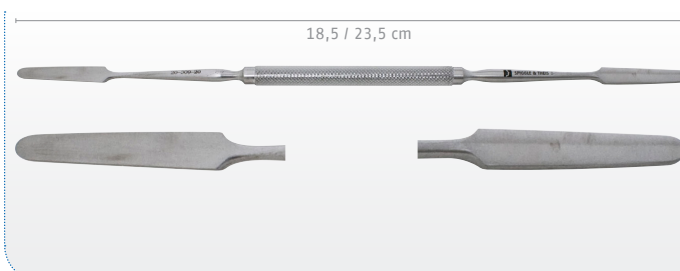

**Killian Raspatorium, doppelseitig, scharf/stumpf**  
Killian raspatory, double ended, sharp/blunt

20-309-18 18,5 cm  
20-309-20 23,5 cm

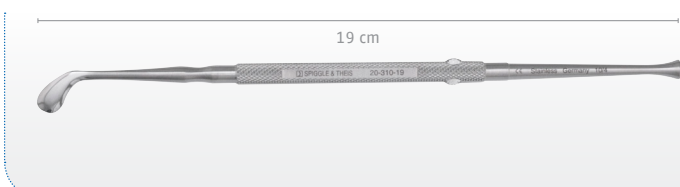

**Freer Golfstock-Raspatorium, 19 cm**  
Freer golf club raspatory, 19 cm

20-310-19

Elevators / Raspatories

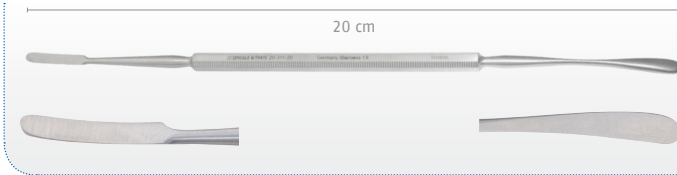

**Freer-Joseph Doppel-Raspatorium, 20 cm**  
Freer-Joseph raspatory, double-ended, 20 cm

20-311-20



**Cottle Tunnel-Raspatorium, doppelseitig, leicht/stark gebogen, 23 cm**  
Cottle tunneling raspatory, double ended, slightly/strongly curved, 23 cm

20-312-23



**Nasensonde, s-förmig gebogen, biegsam, 17,5 cm**  
Nasal probe, s-shaped, bendable, 17.5 cm

20-313-00



**Cottle Raspatorium, gebogen, 19 cm**  
Cottle raspatory, curved, 19 cm

Größe / Size

10-352-08 8 mm  
10-352-14 14 mm

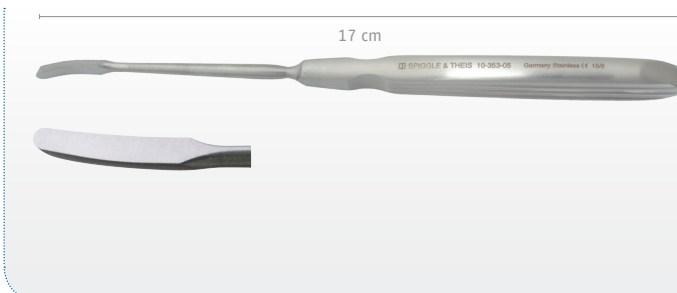

**Lempert Raspatorium, gerade, 17 cm**  
Lempert raspatory, straight, 17 cm

Größe / Size

10-353-02 2 mm  
10-353-03 3 mm  
10-353-04 4 mm  
10-353-05 5 mm

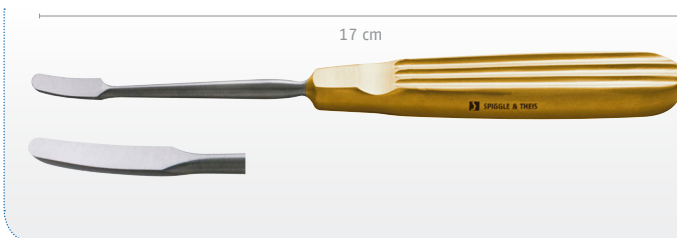

**Raspatorium, gerade, vergoldeter Griff, 17 cm**  
Raspatory, straight, golden handle, 17 cm

10-353-13



**Lempert Raspatorium, stark gebogen, 3 mm, 17 cm**  
Lempert raspatory, strongly curved, 3 mm, 17 cm

10-354-03





**Wullstein Raspatorium, 4 mm breit, 16,5 cm**  
Wullstein raspatory, 4 mm wide, 16.5 cm

10-356-00

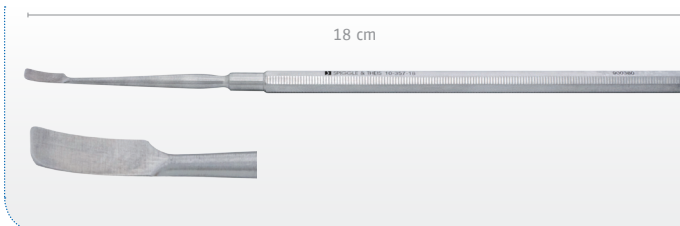

**Freer Raspatorium, vorne eckig, gebogen, 18 cm**  
Freer raspatory, sharp cornered end, curved, 18 cm

10-357-18



**McKenty Raspatorium, stark gebogen, 15 cm**  
McKenty raspatory, strongly curved, 15 cm

Größe / Size

20-318-04 4 mm  
20-318-05 5 mm



**Ulmer Raspatorium, stark gebogen, 4 mm, 17 cm**  
Ulmer raspatory, strongly curved, 4 mm, 17 cm

20-319-04



**Guillen Saugraspatorium**  
Guillen suction raspatory

Größe / Länge /  
Size Length

20-322-01	4,0 mm	20,0 cm	gerade / straight
20-322-02	4,0 mm	20,0 cm	links gebogen / left curved
20-322-03	4,0 mm	21,5 cm	rechts gebogen / right curved
20-323-01	4,0 mm	15,0 cm	gerade / straight
20-323-02	4,5 mm	15,0 cm	links gebogen / left curved
20-323-03	4,5 mm	15,0 cm	rechts gebogen / right curved

## Chisels / Osteotomes / Mallets



**Cottle Hammer, Hammerkopf aus spezialgehärtetem Stahl, 18 cm**  
Cottle mallet, hammerhead made of special tempered steel, 18 cm

20-400-18

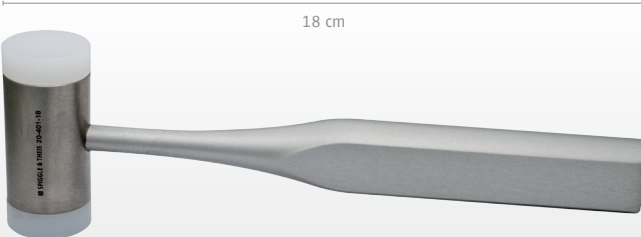

**Metallhammer mit auswechselbaren Nylonbacken, 320 g, 18 cm**  
Metal mallet with replaceable nylon facings, 320 g, 18 cm

20-401-18



**Nylon-Ersatzbacken für Metallhammer 20-401-18 oder 20-403-23, Paar**  
Spare nylon facings for metal mallet 20-401-18 oder 20-403-23, pair

20-401-99

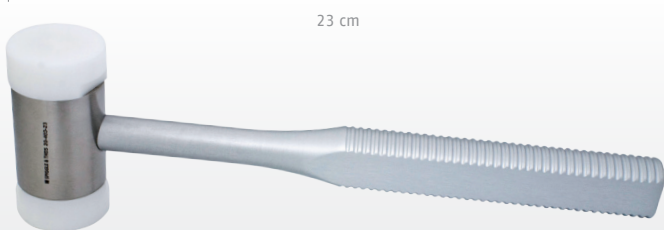

**Hammer mit Alugriff und Metallkopf, auswechselbare Nylon-Backen, 23 cm**  
Mallet with aluminium handle, metal head, replaceable nylon facings, 23 cm

20-403-23



**Hajek Metallhammer, 200 g, 21 cm**  
Hajek metal mallet, 200 g, 21 cm

20-402-21

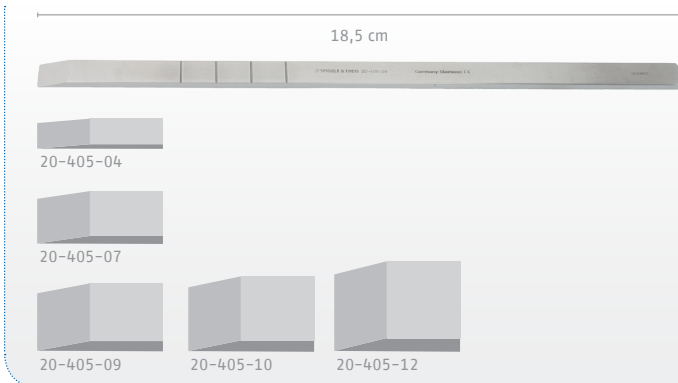

**Cottle Meißel, flach, 18,5 cm**  
Cottle chisel, flat, 18.5 cm

Größe / Size

20-405-04	4 mm
20-405-07	7 mm
20-405-09	9 mm
20-405-10	10 mm
20-405-12	12 mm

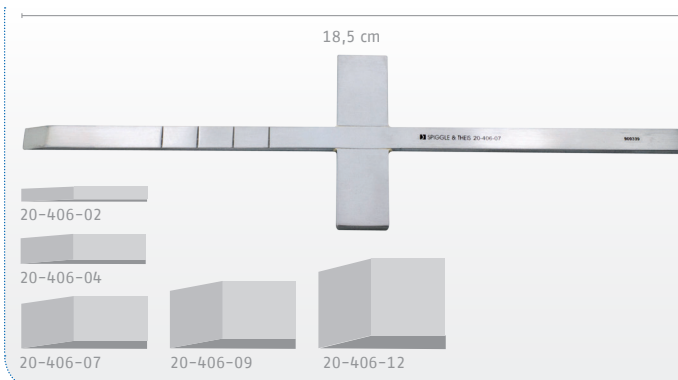

**Cottle Meißel, flach, mit Querbalken, 18,5 cm**  
Cottle chisel, flat, with crossbar, 18.5 cm

Größe / Size

20-406-02	2 mm
20-406-04	4 mm
20-406-07	7 mm
20-406-09	9 mm
20-406-12	12 mm

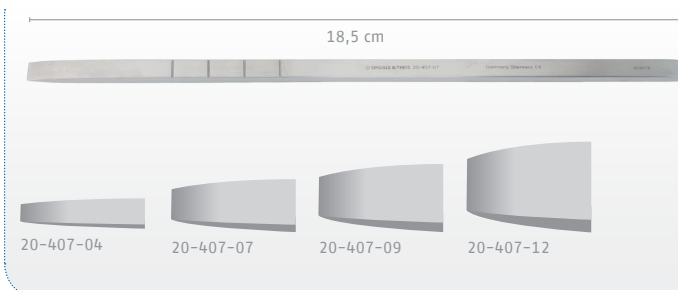

**Cottle Osteotom, flach, 18,5 cm**  
Cottle osteotome, flat, 18.5 cm

Größe / Size

20-407-04	4 mm
20-407-07	7 mm
20-407-09	9 mm
20-407-12	12 mm

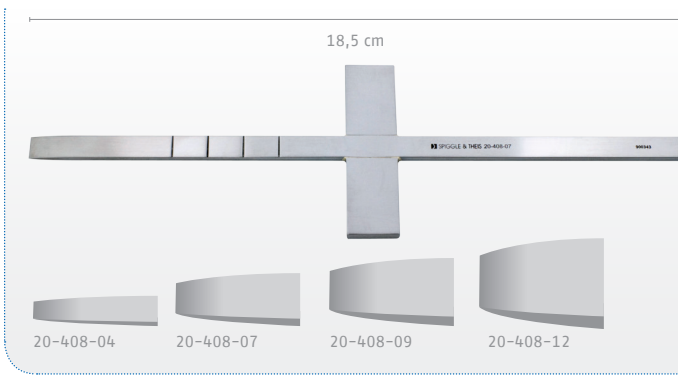

**Cottle Osteotom, flach, mit Querbalken, 18,5 cm**  
Cottle osteotome, flat, with crossbar, 18.5 cm

Größe / Size

20-408-04	4 mm
20-408-07	7 mm
20-408-09	9 mm
20-408-12	12 mm

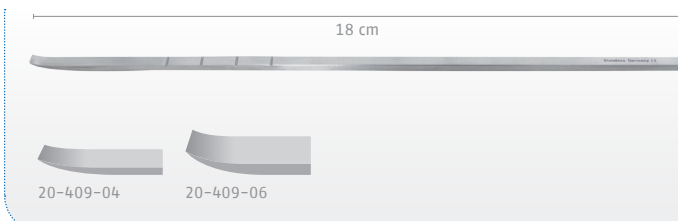

**Cottle Meißel, flach, gebogen, 18 cm**  
Cottle chisel, flat, curved, 18 cm

Größe / Size

20-409-04	4 mm
20-409-06	6 mm

## Chisels / Osteotomes / Mallets

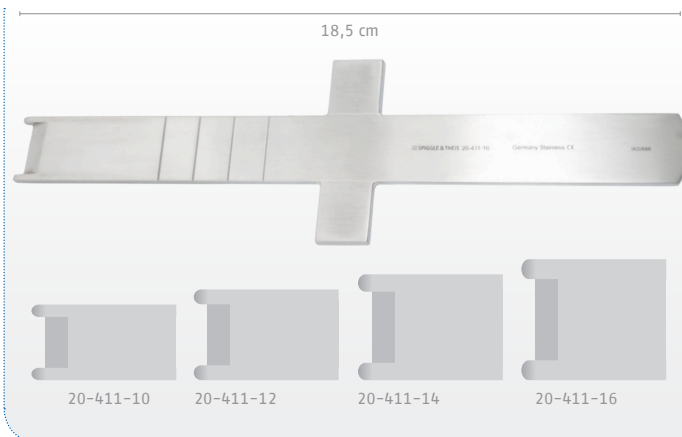

**Cottle Osteotom,**  
2 Führungsdorne, mit Querbalken, 18,5 cm  
Cottle osteotome,  
2 guards, with crossbar, 18.5 cm

## Größe / Size

20-411-10	10 mm
20-411-12	12 mm
20-411-14	14 mm
20-411-16	16 mm

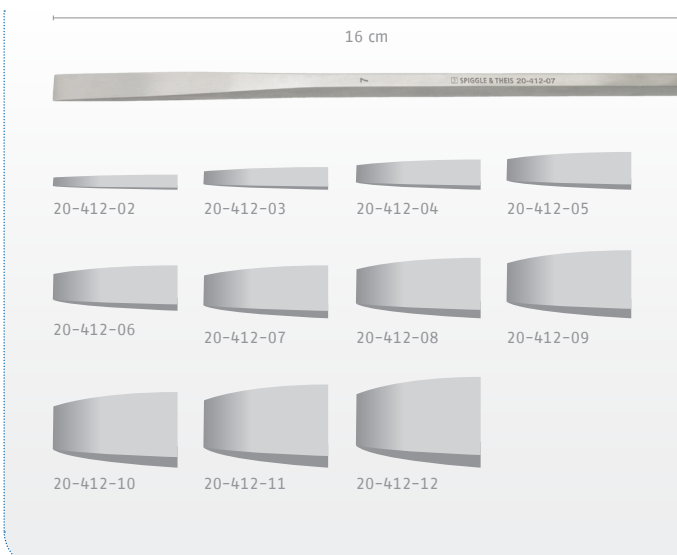

**Rubin Osteotom,**  
Sechskant-Griff, gerade, 16 cm  
Rubin osteotome,  
hexagon handle, straight, 16 cm

## Größe / Size

20-412-02	2 mm
20-412-03	3 mm
20-412-04	4 mm
20-412-05	5 mm
20-412-06	6 mm
20-412-07	7 mm
20-412-08	8 mm
20-412-09	9 mm
20-412-10	10 mm
20-412-11	11 mm
20-412-12	12 mm

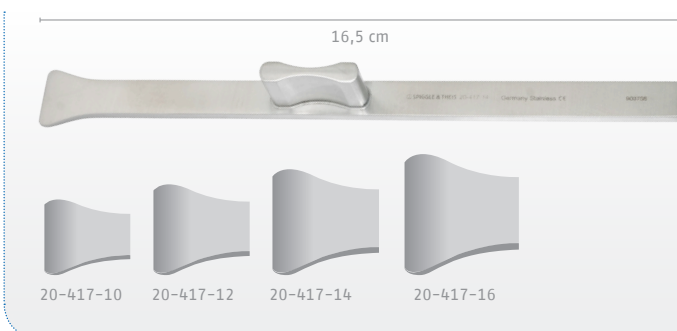

**Rubin Osteotom mit Halteknopf,** 16,5 cm  
Rubin osteotome with stabilizer, 16.5 cm

## Größe / Size

20-417-10	10 mm
20-417-12	12 mm
20-417-14	14 mm
20-417-16	16 mm

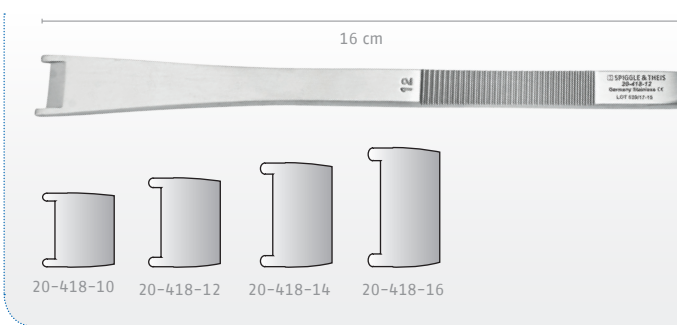

**Cinelli Osteotom,** 2 Führungsdorne, 16 cm  
Cinelli osteotome, double guard, 16 cm

## Größe / Size

20-418-10	10 mm
20-418-12	12 mm
20-418-14	14 mm
20-418-16	16 mm



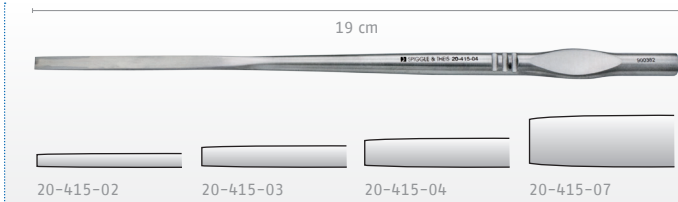

Walter Osteotom, 19 cm  
Walter osteotome, 19 cm

Größe / Size

20-415-02	2 mm
20-415-03	3 mm
20-415-04	4 mm
20-415-07	7 mm

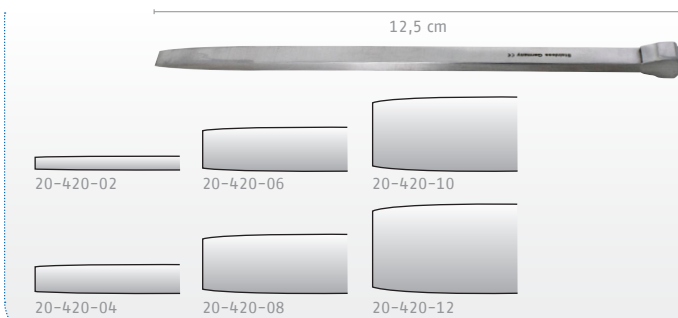

Mini Osteotom, gerade, 12,5 cm  
Mini osteotome, straight, 12.5 cm

Größe / Size

20-420-02	2 mm
20-420-04	4 mm
20-420-06	6 mm
20-420-08	8 mm
20-420-10	10 mm
20-420-12	12 mm



- spezialgehärteter Stahl / specially tempered steel
- perfekt ausbalanciert / perfectly balanced

Osteotom Premium Line, goldener Griff  
Osteotome Premium Line, golden handle

Größe / Size

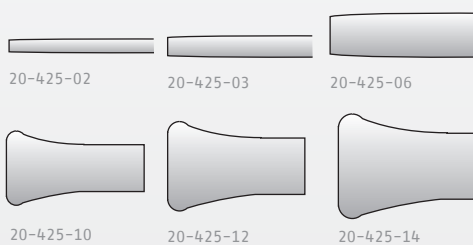

20-425-02	2,0 mm	18,5 cm
20-425-25	2,5 mm	18,5 cm
20-425-03	3,0 mm	18,5 cm
20-425-04	4,0 mm	18,0 cm
20-425-06	6,0 mm	18,0 cm
20-425-10	10,0 mm	18,0 cm
20-425-12	12,0 mm	18,0 cm
20-425-14	14,0 mm	18,0 cm
20-425-16	16,0 mm	18,0 cm
20-425-18	18,0 mm	18,0 cm

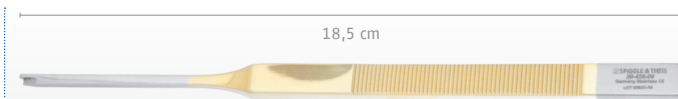

Osteotom Premium Line, satiniertes Griff,  
2,2 mm, mit Schutzsonde, 18,5 cm  
Osteotome, premium line, satined handle,  
2.2 mm, guarded, 18.5 cm

20-426-00

## Chisels / Osteotomes / Mallets

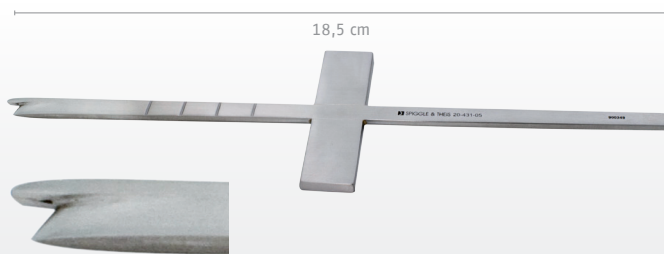

**Cottle Osteotom mit Führungsdorn,  
gerade, 5 mm, 18,5 cm**  
Cottle osteotome with single guard,  
straight, 5 mm, 18.5 cm

20-430-05 ohne Querplatte / without crossbar  
20-431-05 mit Querplatte / with crossbar



**Killian-Claus Hohlmeißel,  
bajonett, 5,5 mm, 16 cm**  
Killian-Claus gouge,  
bayonet, 5.5 mm, 16 cm

20-428-01 gerade / straight  
20-428-02 V-Form / V-shaped



**Walter Hohlmeißel, 19 cm**  
Walter gouge, 19 cm

20-432-03 3,0 mm  
20-432-45 4,5 mm



**Masing Osteotom, 2 Führungsdorne,  
10 mm-Schneide, gerade, 16 cm**  
Masing osteotome, double guard,  
10 mm blade, straight, 16 cm

20-441-16



**Herberhold Osteotom zur lateralen Osteotomie,  
4 mm-Schneide, 18 cm**  
Herberhold osteotome for lateral osteotomy,  
4 mm blade, 18 cm

20-435-01 2 Führungsdorne, gerade /  
double guard, straight  
20-435-02 1 Führungsdorn, links gebogen /  
single guard, left curved  
20-435-03 1 Führungsdorn, rechts gebogen /  
single guard, right curved



**Wurm Osteotom, gerade, mit Schutzsonde, schmale Führungsschiene, Breite 4 mm, 2 mm, 18 cm**  
 Wurm osteotome, straight, with protecting probe, small guide bar, 4 mm width, 2 mm, 18 cm

20-439-01



**Masing Osteotom zur lateralen Osteotomie, 1 Führungsdorn, 3 mm-Schneide, 18 cm**  
 Masing osteotome for lateral osteotomy, single guard, 3 mm blade, 18 cm

- 20-440-01 gerade / straight
- 20-440-02 links gebogen / left curved
- 20-440-03 rechts gebogen / right curved

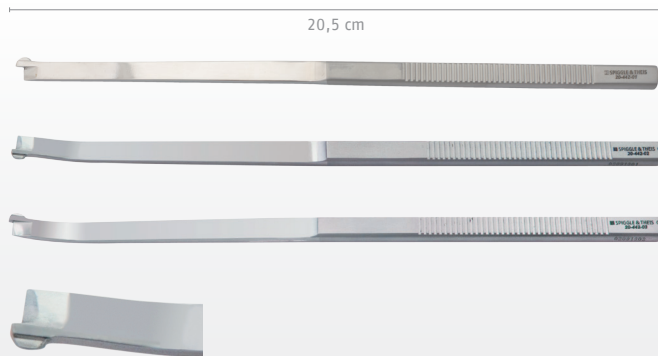

**Anderson-Neivert Osteotom zur lateralen Osteotomie, 1 Führungsdorn, 3,5 mm Schneide, 20,5 cm**  
 Anderson-Neivert osteotome for lateral osteotomy, single guard, 3.5 mm blade, 20.5 cm

- 20-442-01 gerade / straight
- 20-442-02 links gebogen / left curved
- 20-442-03 rechts gebogen / right curved

Knives



Skalpell-Griff  
Scalpel handle

10-360-03	Nr. / No. 3	12,0 cm
10-360-04	Nr. / No. 4	13,5 cm
10-360-07	Nr. / No. 7	16,0 cm
10-360-33	Nr. / No. 3L	21,0 cm

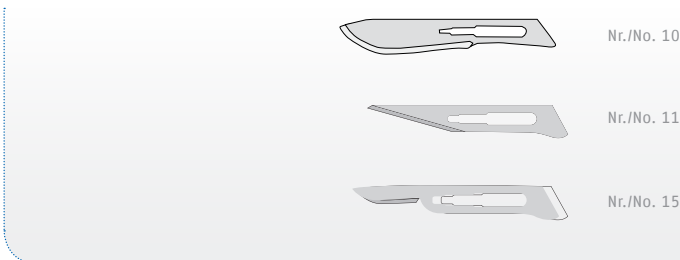

Skalpell-Klingen, einzeln steril verpackt, 100 Stück  
Scalpel blades, single sterile packed, 100 pieces

10-360-10	Nr. / No. 10	
10-360-11	Nr. / No. 11	spitz / pointed
10-360-15	Nr. / No. 15	gerundet / rounded

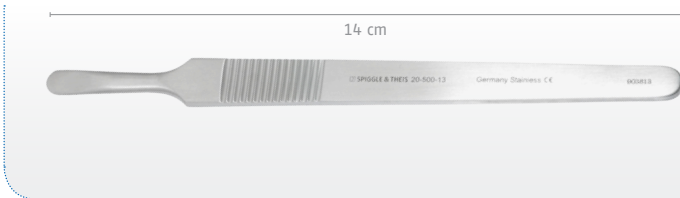

Cottle Septum-Messer, 14 cm  
Cottle septum knife, 14 cm

20-500-13



Masing Ritzmesser, 14 cm  
Masing pointed knife, 14 cm

20-501-14	mit Kerbe / grooved
20-502-14	glatt / plane



Freer Septum Messer, 15 cm  
Freer septum knife, 15 cm

20-502-15



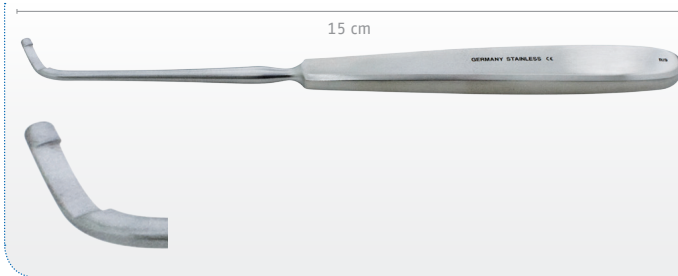

**Joseph Rhinoplastikmesser,  
geknöpft, gewinkelt, 15 cm**  
Joseph rhinoplasty knife,  
button-end, angled, 15 cm

20-503-15

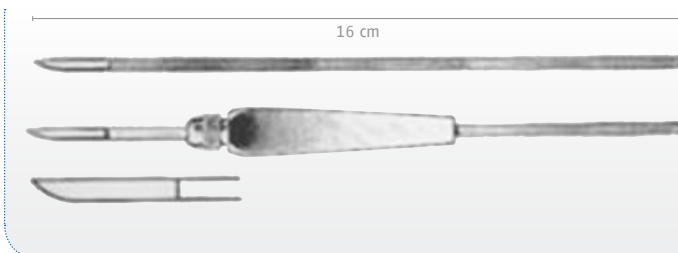

**Brünings Messer  
mit auswechselbarer Klinge, 16 cm**  
Brünings knife  
with exchangeable blade, 16 cm

20-504-17



**Mikro Handgriff, rund**  
Micro handle, round

20-550-10 10 cm  
20-550-13 13 cm



**Mikro-Klingen, gerade, 25 Stück**  
Micro blades, straight, 25 pieces

20-551-62 SM62, vierkant / SM62, square  
20-551-64 SM64, abgerundet / SM64, rounded  
20-551-65 SM65, spitz / SM65, pointed

Retractors



**Cottle Nasenflügelhaken, 16 cm**  
Cottle alar retractor, 16 cm

- 20-560-15 kurzes Blatt / short blade
- 20-561-15 langes Blatt / long blade



**Cottle Nasenhaken, 4 Zähne, stumpf, 13 cm**  
Cottle nasal hook, 4 prongs, blunt, 13 cm

20-562-15

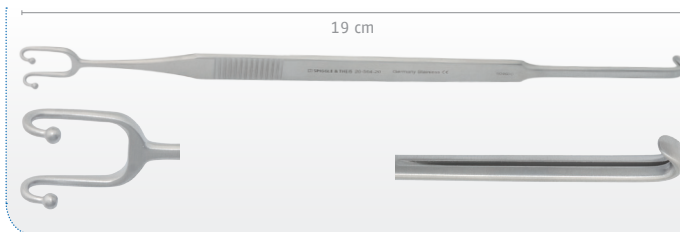

**Cottle-Neivert Doppelhaken, 19 cm**  
Cottle-Neivert double hook, 19 cm

20-564-20



**Neivert Draht-Doppelhaken, 18 cm**  
Neivert wire-shaped retractor, 18 cm

- 20-566-18 11,5 mm
- 20-566-20 13,0 mm



**Converse Nasenflügel-Doppelhaken**  
Converse alar double hook

- 20-572-10 stumpf, 11 cm / blunt
- 20-573-10 scharf, 11,5 cm / sharp





**Aufricht Nasenrückenhaken**  
Aufricht nasal retractor

- 20-567-16 50 mm, 16 cm
- 20-568-16 45 mm, 15,5 cm, extra fein, Goldgriff / extra fine, golden handle



**Aufricht Nasenrückenhaken mit Fiberglas-Lichtträger, Goldgriff, 60 mm, 16 cm**  
Aufricht nasal retractor, with fibre-light carrier, golden handle, 60 mm, 16 cm

20-569-16



**Aufricht Doppelhaken, 11,5 cm**  
Aufricht double retractor, 11.5 cm

20-570-13



**Kilner Wundhäkchen, 2-zinkig, 8 cm**  
Kilner hook, 2 prongs, 8 cm

- 20-571-01 scharf / sharp 10 mm
- 20-571-02 stumpf / blunt 10 mm
- 20-571-03 scharf / sharp 13 mm



**Cottle Fingerring-Häkchen, scharf, 5 cm**  
Cottle thimble hook, sharp, 5 cm

20-574-06

Retractors



**Cottle Hauthäkchen, 1-zinkig, scharf, 16 cm**  
Cottle skin hook, 1 prong, sharp, 16 cm

- 20-576-16 gewinkelt / angled
- 20-577-16 gebogen / curved

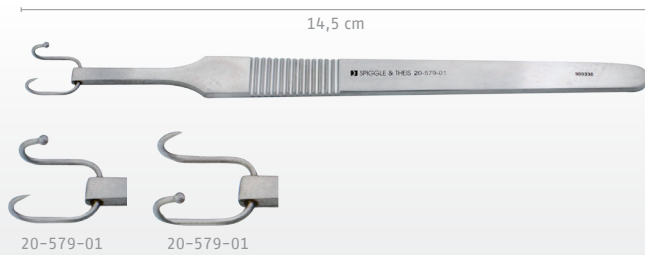

**Cottle Doppel-Haken, 11 mm, 14,5 cm**  
Cottle double hook, 11 mm, 14.5 cm

- 20-579-01 rechts geknöpft, links scharf / right prong blunt, left prong sharp
- 20-579-02 links geknöpft, rechts scharf / left prong blunt, right prong sharp



**Cottle Doppel-Haken, rechts und links scharf**  
Cottle double hook, left and right prong sharp



20-579-03 fein, 11 mm, 14,5 cm / fine  
20-579-04 extrafein, goldener Griff, 10 mm, 12 cm / extra fine, golden handle



**Freer Wundhäkchen, 2-zinkig, scharf, 15 cm**  
Freer hook, 2 prongs, sharp, 15 cm

20-580-15



**Fomon Nasenflügelhaken, 2-zinkig, stumpf, 10 mm, 16,5 cm**  
Fomon alar hook, 2 prongs, blunt, 10 mm, 16.5 cm

20-584-17





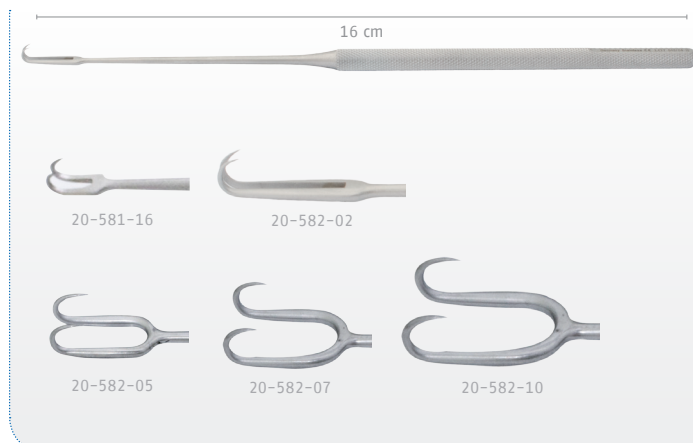

**Joseph Doppel-Häkchen,**  
2-zinkig, scharf, 16 cm  
Joseph double hook,  
2 prongs, sharp, 16 cm

	<b>Abstand Haken / Prongs span</b>
20-581-16	5 mm
	kurze Biegung / short curve
20-582-02	2 mm
20-582-05	5 mm
20-582-07	8 mm
20-582-10	10 mm

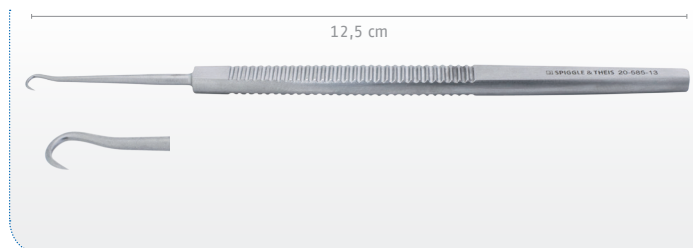

**Gillies Hauthäkchen,**  
1-zinkig, scharf, sehr fein, 12,5 cm  
Gillies skin hook,  
1 prong, sharp, very fine, 12.5 cm

20-585-13



**Cottle Hauthäkchen,**  
1-zinkig, scharf, fein, 14,5 cm  
Cottle skin hook,  
1 prong, sharp, fine, 14.5 cm

20-587-15



**Wundhäkchen,**  
superfein, Goldgriff, 15 cm  
Skin hook,  
very fine, golden handle, 15 cm

20-588-01	ein-zinkig / one prong
20-588-02	zwei-zinkig / two prongs

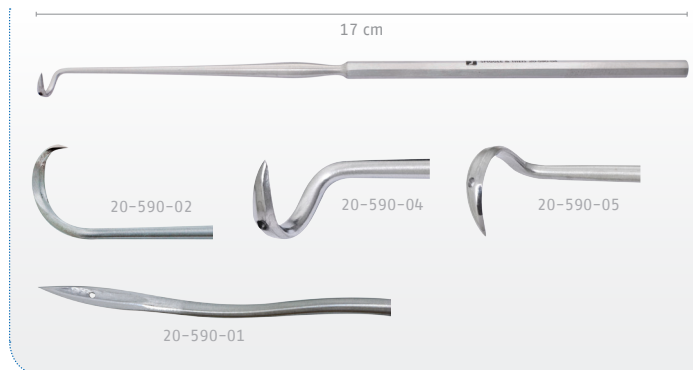

**Yankauer Septumnadel, 17 cm**  
Yankauer septum needle, 17 cm

20-590-01	leicht gebogen, vorwärts / slightly curved, forward
20-590-02	stark gebogen, rückwärts / strongly curved, backward
20-590-04	rechts gebogen / right curved
20-590-05	links gebogen / left curved



Scissors

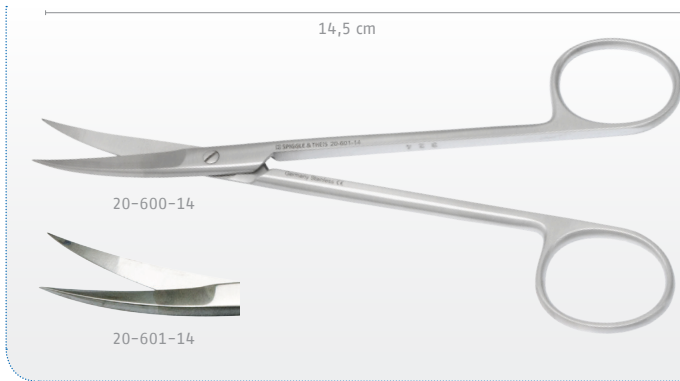

Joseph Schere,  
spitz-spitz, 14,5 cm  
Joseph scissors,  
pointed, 14.5 cm

- 20-600-14 gerade / straight
- 20-601-14 gebogen / curved

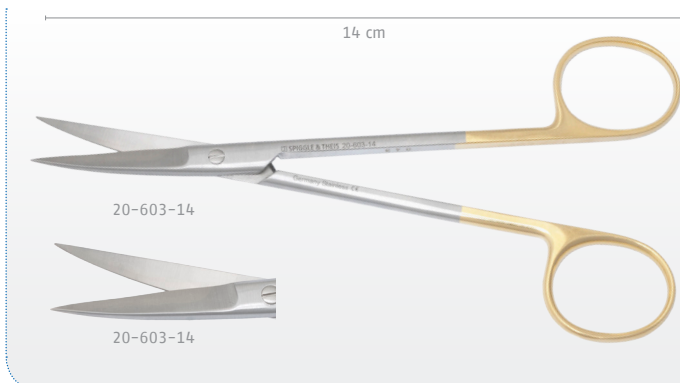

Joseph Schere,  
Hartmetall, spitz-spitz, 14 cm  
Joseph scissors,  
tungsten carbide, pointed, 14 cm

- 20-602-14 gerade / straight
- 20-603-14 gebogen / curved



Joseph Schere,  
supercut, spitz-spitz, 14,5 cm  
Joseph scissors,  
supercut, pointed, 14.5 cm

- 20-604-14 gerade / straight
- 20-605-14 gebogen / curved



Metzenbaum-Fino Schere,  
spitz-spitz, gebogen  
Metzenbaum-Fino scissors,  
pointed, curved

- 20-607-18 18,0 cm
- 20-607-20 20,5 cm





**Reynolds Schere,**  
stumpf-stumpf, gebogen,  
verjüngte Spitzen, 16 cm  
Reynolds scissors,  
blunt, curved, tapered tips, 16 cm

20-610-15



**Reynolds Schere,**  
stumpf-stumpf, supercut, gebogen, 15,5 cm  
Reynolds scissors,  
blunt, supercut, curved, 15.5 cm

20-611-15

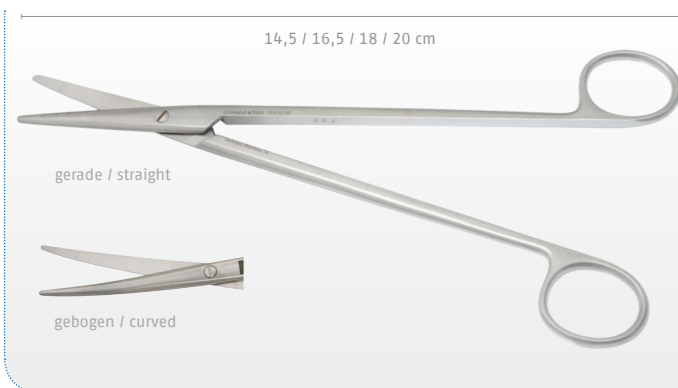

**Metzenbaum Schere, stumpf-stumpf, fein**  
Metzenbaum scissors, blunt, fine

- |           |         |                   |
|-----------|---------|-------------------|
| 20-612-14 | 14,5 cm | gebogen / curved  |
| 20-612-15 | 14,5 cm | gerade / straight |
| 20-612-16 | 16,5 cm | gerade / straight |
| 20-612-18 | 18,0 cm | gerade / straight |
| 20-612-20 | 20,0 cm | gerade / straight |
| 20-614-15 | 14,5 cm | gebogen / curved  |
| 20-614-18 | 18,0 cm | gebogen / curved  |
| 20-614-20 | 20,0 cm | gebogen / curved  |

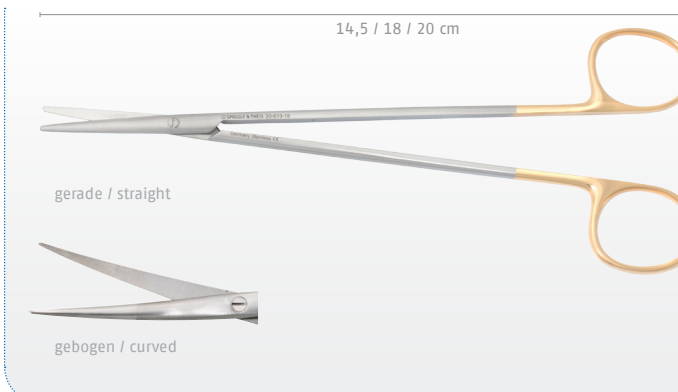

**Metzenbaum Schere,**  
Hartmetall, stumpf-stumpf, fein  
Metzenbaum scissors,  
tungsten Carbide, blunt, fine

- |           |         |                   |
|-----------|---------|-------------------|
| 20-613-15 | 14,5 cm | gerade / straight |
| 20-613-18 | 18,0 cm | gerade / straight |
| 20-613-20 | 20,0 cm | gerade / straight |
| 20-615-15 | 14,5 cm | gebogen / curved  |
| 20-615-18 | 18,0 cm | gebogen / curved  |
| 20-615-20 | 20,0 cm | gebogen / curved  |



Scissors



**Metzenbaum Schere, supercut, stumpf-stumpf, fein, 14,5 cm**  
 Metzenbaum scissors, supercut, blunt, fine, 14.5 cm

20-616-15 gebogen / curved  
 20-618-15 gerade / straight



**Metzenbaum Schere, duracut-ceramic, gebogen, stumpf-stumpf, fein, 14,5 cm**  
 Metzenbaum scissors, duracut ceramic, curved, blunt, fine, 14.5 cm

20-617-15



**Kilner Rhinoplastischere, flache Spitze, stumpf, gebogen, 14 cm**  
 Kilner rhinoplasty scissors, flat end, blunt, curved, 14 cm

20-620-14



**Kilner Rhinoplastischere, supercut, flache Spitze, stumpf, gebogen, 13,5 cm**  
 Kilner rhinoplasty scissors, supercut, flat end, blunt, curved, 13.5 cm

20-621-14



**Kilner Rhinoplastischere, flache Spitze, stumpf-stumpf, gebogen Hartmetall**  
 Kilner rhinoplasty scissors, flat end, blunt, curved, tungsten carbide

20-622-13 13,5 cm  
 20-622-15 15,0 cm





**Stevens Gefäßschere,  
verjüngte Spitzen, 11,5 cm**  
Stevens vascular scissors,  
small tips, blunt, 11.5 cm

- 20-623-11 gerade / straight
- 20-624-11 gebogen / curved
- 20-625-11 gebogen / curved, supercut



**Goldman-Fox Schere,  
verjüngte Spitzen, gebogen,  
unteres Blatt gezahnt, 13 cm**  
Goldman-Fox scissors,  
small tips, curved,  
bottom blade serrated, 13 cm

- 20-626-93 Hartmetall / tungsten carbide
- 20-627-13 supercut
- 20-628-13 duracut ceramic



**Schere,  
spitz-spitz, 11,5 cm**  
Scissors,  
pointed, 11.5 cm

- 10-530-12 gerade / straight
- 10-533-12 gebogen / curved



**Schere,  
supercut, spitz-spitz, 11,5 cm**  
Scissors,  
supercut, pointed, 11.5 cm

- 10-531-12 gerade / straight
- 10-534-12 gebogen / curved





Scissors

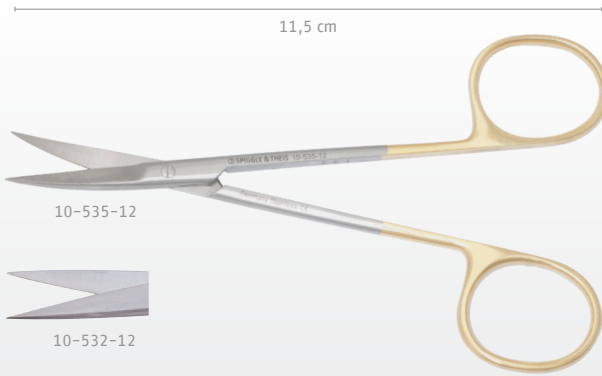

Schere,  
Hartmetall, spitz-spitz, 11,5 cm  
Scissors,  
tungsten carbide, pointed, 11.5 cm

10-532-12 gerade / straight  
10-535-12 gebogen / curved

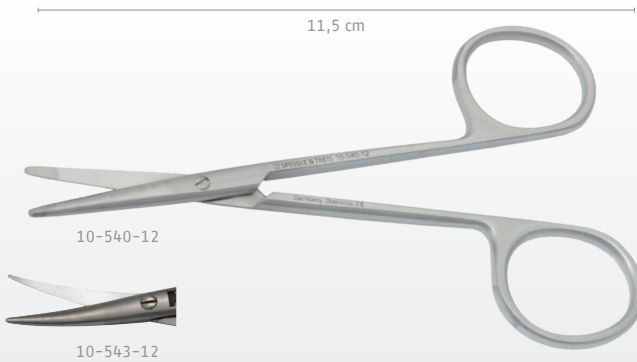

Schere,  
stumpf-stumpf, 11,5 cm  
Scissors,  
blunt, 11.5 cm

10-540-12 gerade / straight  
10-543-12 gebogen / curved



Schere,  
supercut, stumpf-stumpf, 11,5 cm  
Scissors,  
supercut, blunt, 11.5 cm

10-541-12 gerade / straight  
10-544-12 gebogen / curved

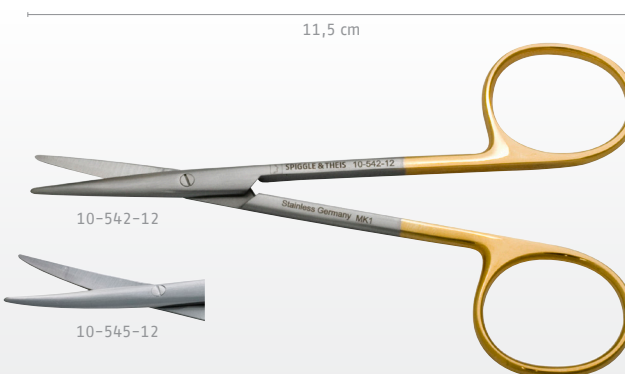

Schere,  
Hartmetall, stumpf-stumpf, 11,5 cm  
Scissors,  
tungsten carbide, blunt, 11.5 cm

10-542-12 gerade / straight  
10-545-12 gebogen / curved



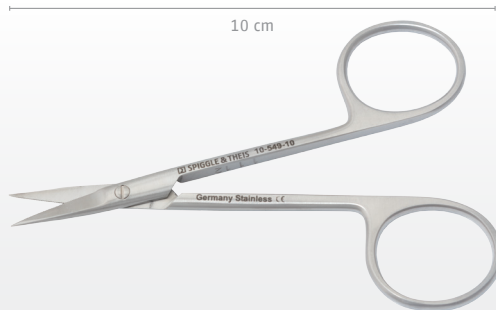

**Schuknecht Drahtschneidescherchen, gezahnt, gerade, 10 cm**  
Schuknecht wire cutting scissors, serrated, straight, 10 cm

10-549-10



**Universalschere, gebogen, spitz-stumpf, 13 cm**  
Universal scissors, curved, sharp-blunt, 13 cm

10-550-13



**Fomon Nasenschere, gebogen, Doppelblatt, 12 cm**  
Fomon nasal scissors, curved, double blade, 12 cm

20-633-12



**Walter Schere, abgewinkelt, 10 cm**  
Walter scissors, curved, angled, 10 cm

20-630-15 Standardausführung / standard version

20-630-10 Vergoldeter Griff / golden handle



Scissors



**Cottle Nasenflügelschere,  
stark gebogen, 12 cm**  
Cottle lower lateral scissors,  
strongly curved, 12 cm

20-632-12



**Cottle Nasenschere,  
gezahnt, gewinkelt, kräftig, 16 cm**  
Cottle lower lateral scissors,  
with teeth, angled, robust, 16 cm

20-638-16



**Cottle Nasenschere,  
gewinkelt, kräftig, Hartmetall, 16 cm**  
Cottle nasal scissors,  
angled, strong, tungsten carbide, 16 cm

20-639-16



**Fomon Nasenschere,  
gezahnt, gewinkelt, fein, 13 cm**  
Fomon dorsal scissors,  
toothed, angled, fine, 13 cm

20-635-13







**Heymann Nasenschere,  
gezahnt, gerade**  
Heymann nasal scissors,  
toothed, straight

- 20-680-16 fein, 16 cm / fine
- 20-683-18 kräftig, 18 cm / strong



**Heymann Nasenschere,  
gezahnt, gebogen, fein, 16 cm**  
Heymann nasal scissors,  
toothed, curved, fine, 16 cm

- 20-681-16 links gebogen / left curved
- 20-682-16 rechts gebogen / right curved



**Conchotomie Schere,  
gezahnt, Rohrschaft, 13 cm**  
Nasal conchotomy scissors,  
toothed, tubular model, 13 cm

- 20-690-01 gerade / straight
- 20-690-02 links gebogen / left curved
- 20-690-03 rechts gebogen / right curved

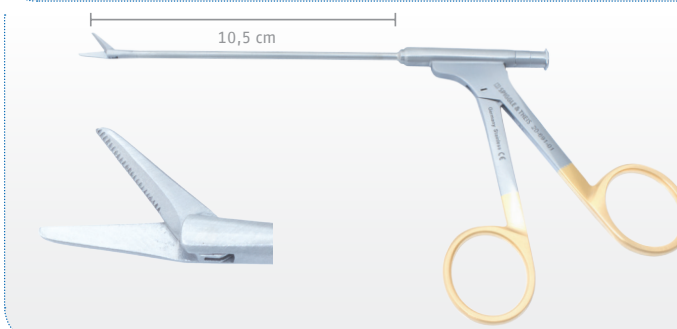

**Weber Nasenschere,  
extra fein, gerade, gezahnt, mit Spülkanal,  
Griff vergoldet, 10,5 cm**  
Weber nasal scissors,  
very fine, straight, toothed, with irrigation  
channel, golden handle, 10.5 cm

- 20-691-01



**Mikro-Gefäßschere, spitz-spitz**  
Micro vascular scissors, pointed

- 20-695-11 gerade, 11 cm / straight
- 20-696-11 gebogen, 11 cm / curved
- 20-697-11 gewinkelt, 10 cm / angled



Forceps / Needle holders



**Cottle Columella-Klemme, 11 cm**  
Cottle columella forceps, 11 cm

20-700-10



**Cottle Columella-Klemme für Kinder, 8,5 cm**  
Cottle columella forceps for children, 8.5 cm

20-701-08



**Herberhold Hautfasszange,  
2:2 Zähne, extra fein, 13,5 cm**  
Herberhold tissue forceps,  
2:2 teeth, extra fine, 13.5 cm

20-705-14

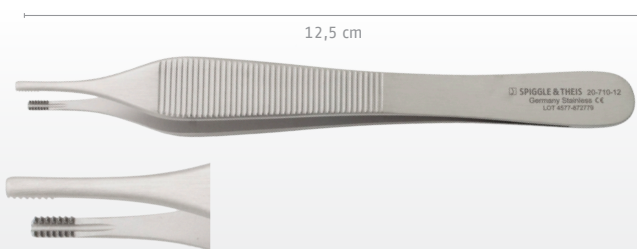

**Adson-Brown Pinzette, 7:8 Zähne, 12,5 cm**  
Adson-Brown forceps, 7:8 teeth, 12.5 cm

20-710-12

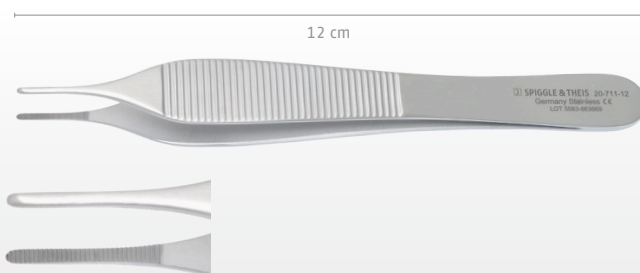

**Adson Pinzette, anatomisch, 12 cm**  
Adson dressing forceps, anatomical, 12 cm

20-711-12



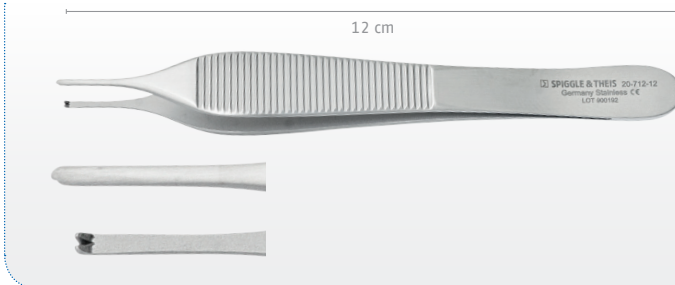

**Adson Pinzette, chirurgisch,  
1:2 Zähne, 12 cm**  
Adson dressing forceps,  
1:2 teeth, 12 cm

20-712-12

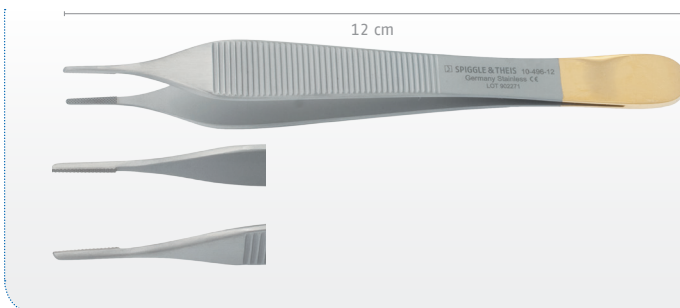

**Adson Pinzette, anatomisch,  
Hartmetall, 12 cm**  
Adson dressing forceps, anatomical,  
tungsten carbide, 12 cm

10-496-12

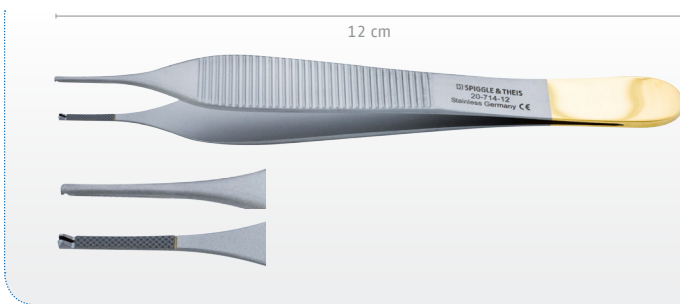

**Adson Pinzette, chirurgisch,  
Hartmetall, 1:2 Zähne, 12 cm**  
Adson dressing forceps,  
tungsten carbide, 1:2 teeth, 12 cm

20-714-12



**Adson-Brown-Pinzette,  
Hartmetall, 7:8 Zähne, 12 cm**  
Adson-Brown dressing forceps,  
tungsten carbide, 7:8 teeth, 12 cm

20-713-12

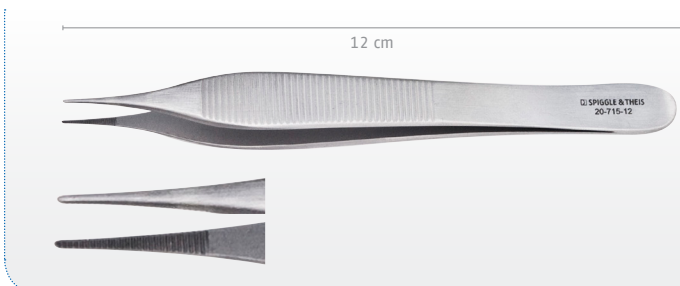

**Mikro-Adson-Pinzette, anatomisch, 12 cm**  
Micro Adson forceps, anatomical, 12 cm

20-715-12

## Forceps / Needle holders

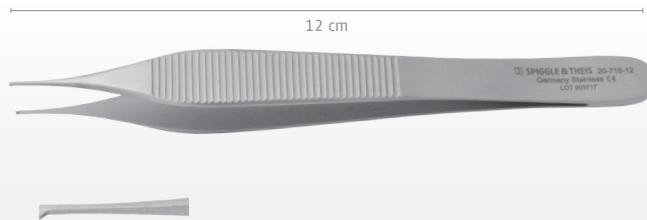

**Mikro-Adson-Pinzette, chirurgisch,  
1:2 Zähne, 12 cm**  
Micro Adson forceps,  
1:2 teeth, 12 cm

20-716-12



**DeBakey Pinzette, atraumatisch,  
gerade, 15 cm**  
DeBakey dressing forceps, atraumatic,  
straight, 15 cm

Spitze / Tip

10-486-16 2,0 mm

10-487-16 1,5 mm

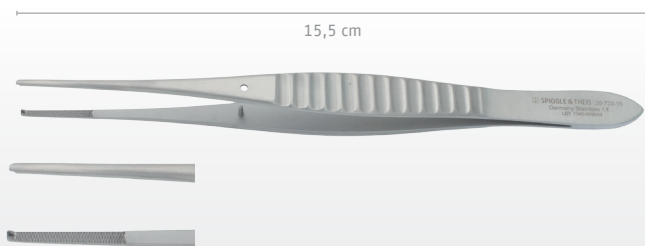

**Gillies Gewebepinzette,  
gerieft mit 1:2 Zähnen, 15,5 cm**  
Gillies tissue forceps,  
serrated with 1:2 teeth, 15.5 cm

20-722-15

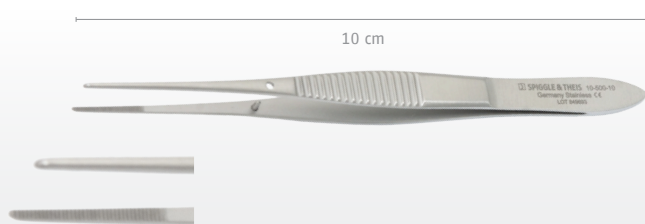

**Graefe Pinzette, anatomisch,  
gerade, 0,7 mm, 10 cm**  
Graefe dressing forceps, anatomical,  
straight, 0.7 mm, 10 cm

10-500-10

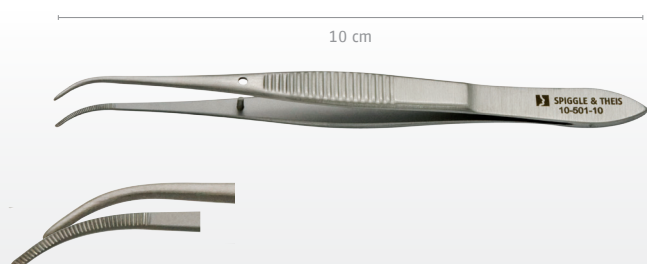

**Graefe Pinzette, anatomisch,  
gebogen, 0,7 mm, 10 cm**  
Graefe dressing forceps, anatomical,  
curved, 0.7 mm, 10 cm

10-501-10

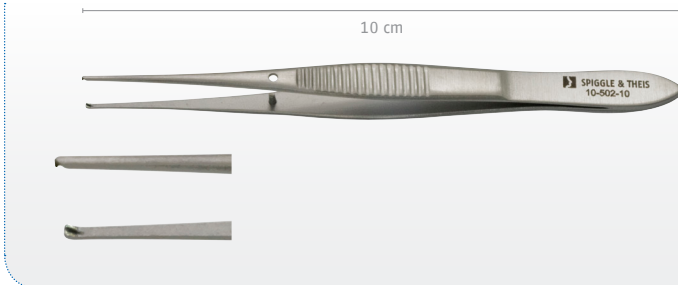

**Graefe Pinzette, chirurgisch,  
1:2 Zähne, gerade, 0,7 mm, 10 cm**  
Graefe dressing forceps,  
1:2 teeth, straight, 0.7 mm, 10 cm

10-502-10

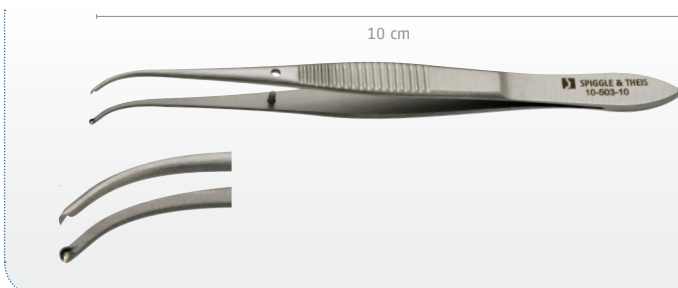

**Graefe Pinzette, chirurgisch,  
1:2 Zähne, gebogen, 0,7 mm, 10 cm**  
Graefe dressing forceps,  
1:2 teeth, curved, 0.7 mm, 10 cm

10-503-10

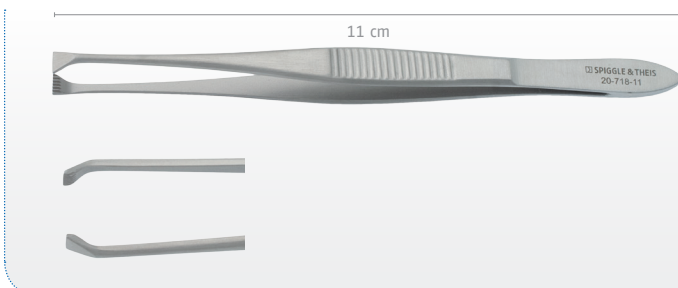

**Graefe Mäusezähnnchen Pinzette,  
7:8 Zähne, 11 cm**  
Graefe tissue forceps,  
7:8 teeth, 11 cm

20-718-11

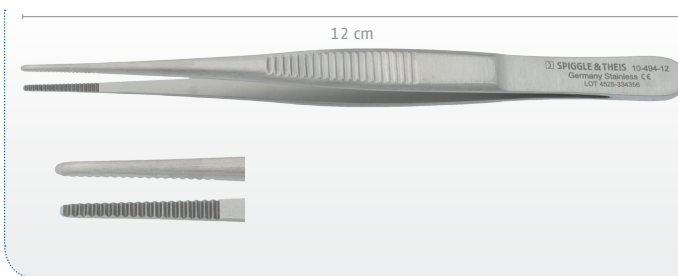

**Pinzette, anatomisch,  
gerade, 1,3 mm, 12 cm**  
Dressing forceps, anatomical,  
straight, 1.3 mm, 12 cm

10-494-12

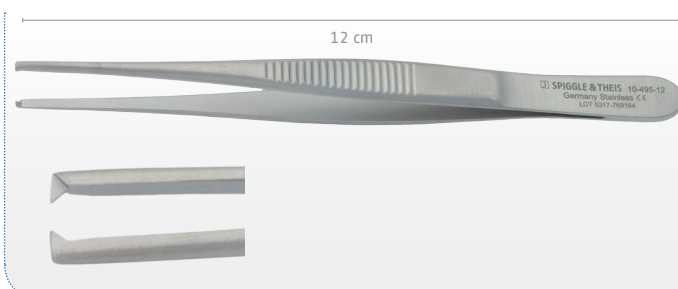

**Pinzette, chirurgisch,  
1:2 Zähne, gerade, 1,5 mm, 12 cm**  
Dressing forceps,  
1:2 teeth, straight, 1.5 mm, 12 cm

10-495-12

Forceps / Needle holders



**Cottle Nasenpinzette, bajonett, mit Schraube, gerieft mit Dornen, 14 cm**  
Cottle lower lateral forceps, bayonet, with screw, serrated with thorns, 14 cm

20-720-14



**Crile-Wood Nadelhalter, Hartmetall, 15 cm**  
Crile-Wood needle holder, tungsten carbide, 15 cm

20-740-15

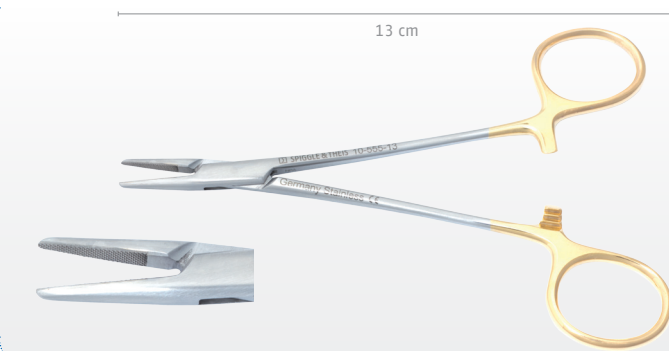

**Halsey Nadelhalter, Hartmetall, fein, 13 cm**  
Halsey needle holder, tungsten carbide, fine, 13 cm

10-555-13



**Neivert Nadelhalter, Hartmetall, fein, 13 cm**  
Neivert needle holder, tungsten carbide, fine, 13 cm

20-742-13

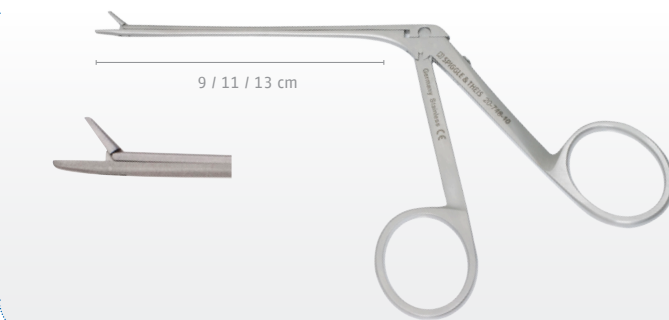

**Masing Nadelhalter, glattes Maul, abgewinkelter Daumenring**  
Masing needle holder, smooth jaws angled thumb ring

AL / WL

20-748-10 9 cm

20-748-11 11 cm

20-748-13 13 cm





**Senning Nadelhalter,  
Hartmetall, extra schlank**  
Senning needle holder,  
tungsten carbide, extra slender

20-744-15 15 cm  
20-744-17 17 cm



**Mikro-Ryder Nadelhalter,  
Hartmetall, verjüngte Spitzen, 15 cm**  
Micro Ryder needle holder,  
tungsten carbide, small ends, 15 cm

20-745-15



**Converse Nadelhalter,  
Hartmetall, sehr fein, 12 cm**  
Converse needle holder,  
tungsten carbide, very fine, 12 cm

20-746-12



**Castroviejo Mikro-Gefäß-Nadelhalter,  
mit Sperre**  
Castroviejo micro vascular needle holder,  
with ratchet

20-760-11 gerade / straight 10,5 cm  
20-760-14 gerade / straight 14,5 cm  
20-761-14 gebogen / curved 14,5 cm

Rasps

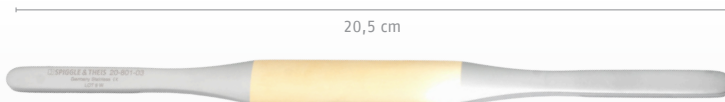

**Fomon Nasenraspel,**  
Hartmetall, doppelseitig, besonders flach,  
20,5 cm  
Fomon nasal rasp,  
tungsten carbide, double ended, very flat,  
20.5 cm

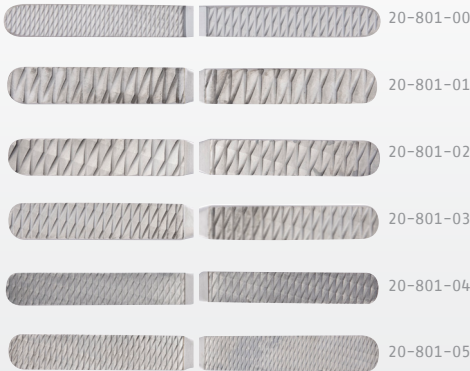

- 20-801-00 Körnung 2/5 = grob/mittel / grain size 2/5 = coarse/medium
- 20-801-01 Körnung 1/2 = grob / grain size 1/2 = coarse
- 20-801-02 Körnung 3/4 = grob/mittel / grain size 3/4 = coarse/medium
- 20-801-03 Körnung 5/6 = mittel / grain size 5/6 = medium
- 20-801-04 Körnung 7/8 = mittel/fein / grain size 7/8 = medium/fine
- 20-801-05 Körnung 9/10 = fein / grain size 9/10 = fine



**Handgriff, doppelendig, für Hartmetall**  
**Raspeleinsätze 20-804-01 bis -10, 15 cm**  
Handle, double ended, for tungsten carbide  
rasps 20-804-01 up to -10, 15 cm

20-804-00

- 20-804-01 Raspeleinsatz, Hartmetall, Körnung 1 = sehr grob / Insert for rasp, tungsten carbide, grain size 1 = very coarse
- 20-804-02 Raspeleinsatz, Hartmetall, Körnung 2 = grob / Insert for rasp, tungsten carbide, grain size 2 = coarse
- 20-804-03 Raspeleinsatz, Hartmetall, Körnung 3 = mittel-grob / Insert for rasp, tungsten carbide, size 3 = medium-coarse
- 20-804-04 Raspeleinsatz, Hartmetall, Körnung 4 = mittel / Insert for rasp, tungsten carbide, size 4 = medium
- 20-804-05 Raspeleinsatz, Hartmetall, Körnung 5 = mittel / Insert for rasp, tungsten carbide, size 5 = medium
- 20-804-06 Raspeleinsatz, Hartmetall, Körnung 6 = mittel-fein / Insert for rasp, tungsten carbide, size 6 = medium-fine
- 20-804-07 Raspeleinsatz, Hartmetall, Körnung 7 = fein / Insert for rasp, tungsten carbide, size 7 = fine
- 20-804-08 Raspeleinsatz, Hartmetall, Körnung 8 = fein / Insert for rasp, tungsten carbide, size 8 = fine
- 20-804-09 Raspeleinsatz, Hartmetall, Körnung 9 = sehr fein / Insert for rasp, tungsten carbide, size 9 = very fine
- 20-804-10 Raspeleinsatz, Hartmetall, Körnung 10 = extra fein / Insert for rasp, tungsten carbide, size 10 = extra fine
- 20-804-20 Raspeleinsatz, Hartmetall, **Diamant** / Insert for rasp, tungsten carbide, **diamond**
- 20-804-99 Schlüssel für "Handgriff, doppelendig" (20-804-00)  
Key for "handle, double ended" (20-804-00)







**Maltz Nasenraspel,**  
**Hartmetall, mit Blutrinne, einseitig, 17,5 cm**  
 Maltz nasal rasp, tungsten carbide,  
 with blood groove, single ended, 17.5 cm

- 20-805-01 auf Zug schneidend / down-cutting
- 20-805-02 auf Druck schneidend / up-cutting

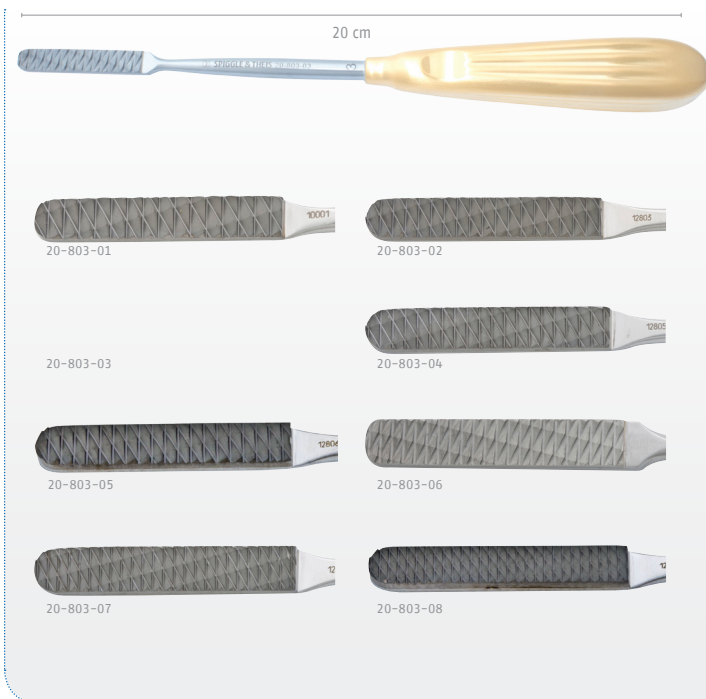

**Parkes Nasenraspel,**  
**Hartmetall, einseitig, 20 cm**  
 Parkes nasal rasp,  
 tungsten carbide, single ended, 20 cm

- 20-803-01 Körnung 1 = grob / grain size 1 = coarse
- 20-803-02 Körnung 2 = grob / grain size 2 = coarse
- 20-803-03 Körnung 3 = grob / grain size 3 = coarse
- 20-803-04 Körnung 4 = mittel / grain size 4 = medium
- 20-803-05 Körnung 5 = mittel / grain size 5 = medium
- 20-803-06 Körnung 6 = mittel / grain size 6 = medium
- 20-803-07 Körnung 7 = fein / grain size 7 = fine
- 20-803-08 Körnung 8 = fein / grain size 8 = fine

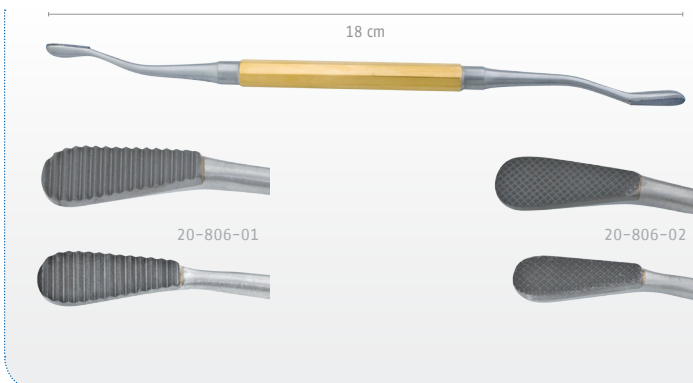

**Miller Nasenraspel,**  
**Hartmetall, doppelseitig, 18 cm**  
 Miller nasal rasp,  
 tungsten carbide, double ended, 18 cm

- 20-806-01 quergerieft / cross cut
- 20-806-02 karogrieft / square cut

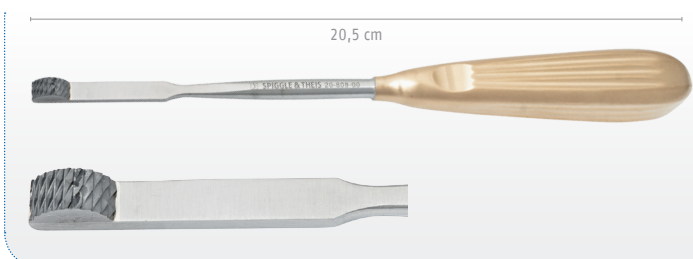

**Aufricht Glabella Raspel,**  
**Hartmetall, einseitig, 20,5 cm**  
 Aufricht glabella rasp,  
 tungsten carbide, single ended, 20.5 cm

- 20-808-00

Rasps

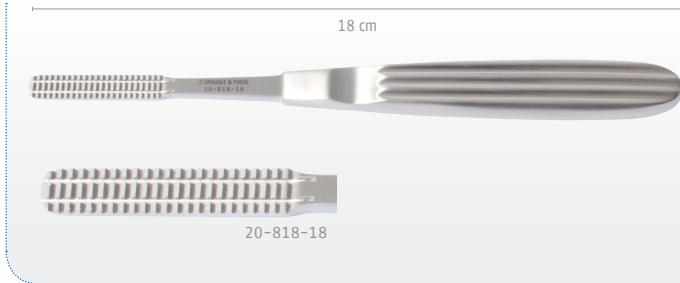

Malt Nasenraspel,  
mit 2 Blutrinnen, einseitig, 18 cm  
Malt nasal rasp,  
with 2 blood grooves, single ended, 18 cm

20-818-18 auf Zug schneidend / down-cutting  
20-819-18 auf Druck schneidend / up-cutting



Cottle Nasenraspel, **Diamant**,  
einseitig, goldener Griff, 19 cm  
Cottle nasal rasp, **diamond**,  
single ended, golden handle, 19 cm

20-811-19 gerade / straight  
20-812-19 gebogen / curved

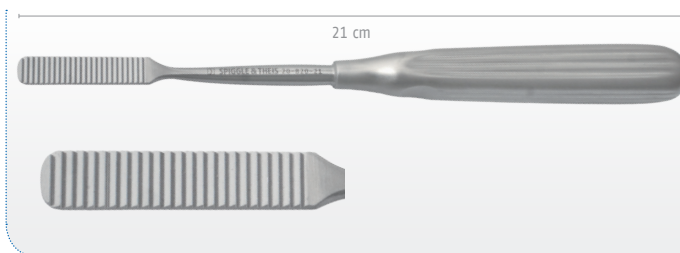

Cottle Nasenraspel,  
einseitig, auf Zug schneidend, 21 cm  
Cottle nasal rasp,  
single ended, down cutting, 21 cm

20-820-21



Masing Nasenraspel, doppelseitig, 21,5 cm  
Masing nasal rasp, double ended, 21.5 cm

20-815-21 feiner Hieb / fine cut  
20-816-21 grober Hieb / coarse cut



Fomon Nasenraspel, **Diamant**,  
goldener Griff, doppelseitig, 20,5 cm  
Fomon nasal rasp, **diamond**,  
golden handle, double ended, 20.5 cm

20-810-21



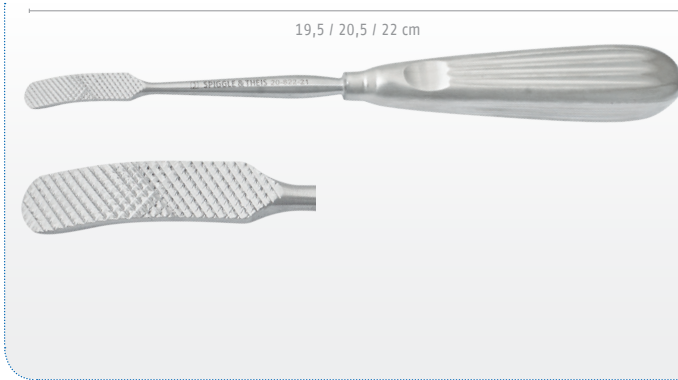

**Aufricht Glabella Raspel, einseitig**  
Auricht glabella rasp, single ended

- 20-822-21 auf Zug und Druck schneidend, 19,5 cm /  
up and down cutting, 19.5 cm
- 20-823-21 auf Zug schneidend, 20,5 cm /  
down cutting, 20.5 cm
- 20-824-21 auf Druck schneidend, 22 cm /  
up cutting, 22 cm



**Aufricht Glabella Raspel, einseitig, auf Druck und Zug schneidend, vergoldeter Griff, 19 cm**  
Auricht glabella rasp, single ended, up and down cutting, golden handle, 19 cm

20-825-18



**Anderson Nasenraspel, einseitig, 30° schräg gezahnt, 21 cm**  
Anderson nasal rasp, single ended, 30° bevelled serrated, 21 cm

- 20-826-21 auf Zug schneidend / down cutting
- 20-827-21 auf Druck schneidend / up cutting

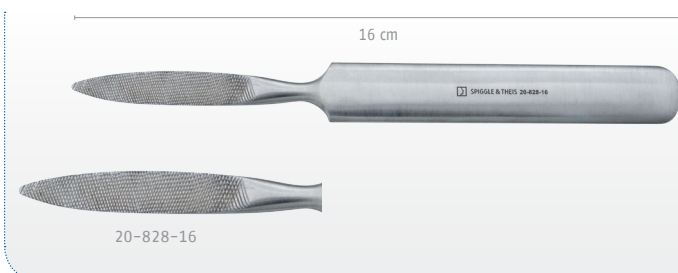

**Joseph Nasenraspel, einseitig, 16 cm**  
Joseph nasal rasp, single ended, 16 cm

- 20-828-16 fein / fine
- 20-829-16 grob / coarse



**Kleinert-Kutz Nasenraspel, doppelendig, vierseitig, mit je 2 Seiten fein (flach) und grob (konvex/flach) gerieft, 20,5 cm**  
Kleinert-Kutz nasal rasp, **double ended, 4-sided**, 2 sides fine (flat) and 2 sides coarse (convex/flat), serrated, 20.5 cm

20-830-21

Miscellaneous



**Aufricht Nasenfraktur-Elevatorium, gerade, konisch, 17,5 cm**  
 Aufricht nasal fracture elevator, straight, conical, 17.5 cm

20-850-20



**Boies Elevatorium, gerade, oval, fein, 18,5 cm**  
 Boies elevator, straight, oval, fine, 18.5 cm

20-851-18



**Castroviejo Nasenzirkel, 8 cm**  
 Castroviejo nasal caliper, 8 cm

20-852-07

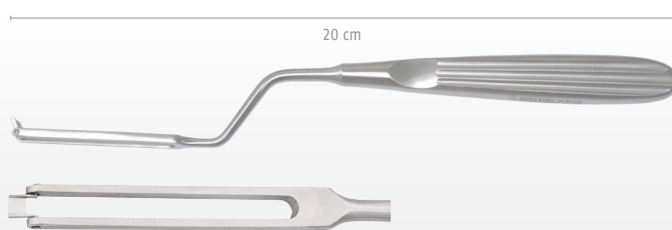

**Ballenger-Messer, schwenkbar, bajonett, 20 cm**  
 Ballenger knife, movable, bayonet, 20 cm

20-853-03 3 mm  
 20-853-04 4 mm





**Joseph Anlegeinstrument zur Rhinoplastik, gewinkelt, 17 cm**  
Joseph placing instrument for rhinoplasty, angled, 17 cm

20-856-17

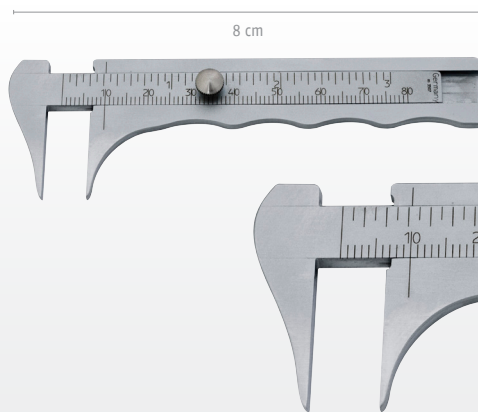

**Jameson Profilometer, Edelstahl, 8 cm**  
Jameson caliper, stainless steel, 8 cm

20-857-00



**Joseph Nasensäge, 19 cm**  
Joseph nasal saw, 19 cm

- 20-860-01 gerade / straight
- 20-860-02 bajonett, rechts / bayonet, right
- 20-860-03 bajonett, links / bayonet, left



**Cottle Knochen- und Knorpelquetscher, mit Entnahmfeder, zerlegbar**  
Cottle bone- and cartilage crusher, with clamp, dismantlable

- 20-865-30 3 cm
- 20-865-50 6 cm

## Miscellaneous

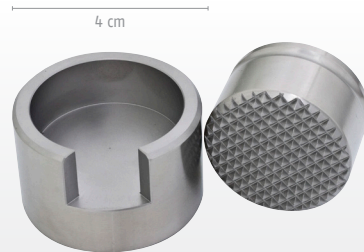

**Tolsdorff Knochen- und Knorpelquetscher, rund, 4 cm, Parallelhub**  
Tolsdorff bone- and cartilage crusher, round, 4 cm, parallel lift

20-867-40 Geriefte Schlagfläche / serrated surface  
20-868-40 Glatte Schlagfläche / even surface



**Non-Stick bipolare Pinzette, 1 mm, 16 cm**  
Non-Stick bipolar forceps, 1 mm, 16 cm

80-101-16 gerade / straight  
80-106-16 abgewinkelt / angled  
80-111-16 bajonett / bayonet



**Spezial-Ölspray, Pflegespray für Instrumente, Dose 500 ml**  
Special oil spray, maintenance spray for instruments, 500 ml

80-650-00



**Bipolares Anschlusskabel für Instrumente, Olympus/Söring/Coa/Erbe-Vio Intl., autoklavierbar**

Bipolar connecting cable for instruments, Olympus/Söring/Coa/Erbe-Vio Intl., autoclavable

80-016-50 5 m



**Bipolares Anschlusskabel,  
passend für Sutter/Martin/Berchtold/Aesculap/  
Integra/Spiggle & Theis**  
Bipolar connecting cable,  
compatible with Sutter/Martin/Berchtold/  
Aesculap/Integra/Spiggle & Theis

80-017-30 3 m  
80-017-50 5 m



**Bipolares Anschlusskabel,  
passend für Erbe/Storz/Wolf**  
Bipolar connecting cable,  
compatible with Erbe/Storz/Wolf

80-018-30 3 m  
80-018-50 5 m



**Bipolares Anschlusskabel,  
passend für Valleylab/Lamidey/Bowa/EMC**  
Bipolar coagulation cable,  
compatible with Valleylab/Lamidey/Bowa/EMC

80-019-30 3 m  
80-019-50 5 m



**Bipolares Anschlusskabel für bipolare Scheren,  
passend für Sutter/Martin/Berchtold/Aesculap/  
Integra/Spiggle & Theis, autoklavierbar**  
Bipolar connecting cable for bipolar scissors,  
compatible with Sutter/Martin/Berchtold/  
Aesculap/Integra/Spiggle & Theis, autoclavable

80-020-30 3 m  
80-020-50 5 m



**Bipolares Anschlusskabel für bipolare Scheren,  
passend für Erbe/Storz/Wolf**  
Bipolar connecting cable for bipolar scissors,  
compatible with Erbe/Storz/Wolf

80-022-30 3 m  
80-022-50 5 m

## Miscellaneous



**Metallschale**  
Metal bowl

80-501-01	B1	Ø 4,0 cm	H=1,9 cm	20 ml
80-501-02	B2	Ø 6,0 cm	H=3,9 cm	60 ml
80-501-03	B4	Ø 8,5 cm	H=4,0 cm	160 ml
80-501-04	B6	Ø 11,0 cm	H=5,5 cm	400 ml



**Medizinbecher, Edelstahl, graduert**  
Medicine cup, stainless steel, graduated

80-503-03	Ø 5,0 cm	H=2,5 cm	30 ml
80-504-05	Ø 5,3 cm	H=4,5 cm	50 ml



**Lösungsschale, Edelstahl**  
Solution bowl, stainless steel

80-506-30	B1	Ø 10,0 cm	H=6,0 cm	300 ml
80-507-40	B2	Ø 12,0 cm	H=7,0 cm	400 ml
80-509-75	B3	Ø 15,0 cm	H=7,5 cm	750 ml



**Tablettenschale, Edelstahl, Ø 6,5 cm, H=2 cm**  
Tablet dish, stainless steel, Ø 6.5 cm, H=2 cm

80-512-00



**Petrirschale, Klarglas, mit Deckel**  
Petri bowl, clear glass, with lid

	Ø	Höhe / Height
80-515-06	6,0 cm	1,5 cm
80-515-08	8,0 cm	1,5 cm
80-515-10	15,0 cm	2,0 cm



**Medikamenten-Schälchen,**  
Glas, schwarz, mit Deckel, 4 x 4 cm  
Medicine cup,  
glass, black, with lid, 4 x 4 cm

80-517-00





**Medikamenten-Schälchen,  
Dappenglas, farbig, Ø 3,2 cm**  
Medicine cup,  
dappen-glass, coloured, Ø 3.2 cm

- 80-519-00 kristall / crystal
- 80-519-01 grün / green
- 80-519-02 rosa / pink
- 80-519-03 topas / topaz



**Porzellan-Schälchen, rund, mit Ausguss**  
China bowl, round, with nozzle

- |           |         |
|-----------|---------|
|           | Ø       |
| 80-520-06 | 8,0 cm  |
| 80-520-08 | 10,0 cm |



**Nierenschale, Edelstahl**  
Kidney bowl, stainless steel

- 80-525-17 17,5 cm
- 80-525-25 25,0 cm



**Kornzangen-Behälter, Edelstahl**  
Forceps holder, stainless steel

- |           |        |               |
|-----------|--------|---------------|
|           | Ø      | Höhe / Height |
| 80-528-13 | 5,0 cm | 13,5 cm       |
| 80-528-18 | 5,0 cm | 18,0 cm       |
| 80-528-20 | 9,5 cm | 20,0 cm       |



**Kornzangen-Behälter,  
Glas, Edelstahldeckel mit  
Ausschnitt, Ø 8 cm, Höhe 20 cm**  
Forceps holder,  
glass, stainless steel lid with  
opening, Ø 8 cm, height 20 cm

- 80-530-20

## Sterilizing Systems



**Norm-Sterilisations-Container,  
Normal-Boden, Ventil-Deckel mit Thermoloc,  
Aluminium, Griff-Farbe nach Wahl**  
Norm sterilisation container,  
unperforated bottom, valve lid with thermoloc,  
aluminium, handle color of your choice

80-630-12	29,6 x 27,5 x 12,0 cm
80-660-14	59,6 x 27,5 x 14,0 cm
80-660-21	59,6 x 27,5 x 21,0 cm



**Siebkorb, Edelstahl-Drahtgeflecht, Fallgriffe**  
Basket, stainless-steel wire mesh, slide handles

80-670-25	24,5 x 24,5 x 6,0 cm
80-670-40	40,0 x 24,5 x 6,0 cm
80-670-49	48,5 x 24,5 x 6,0 cm



**Codier-Schild, 6 x 2 cm, 20 Zeichen**  
Coding label, 6 x 2 cm, 20 characters

80-680-01	schwarz / black
80-680-02	rot / red
80-680-03	braun / brown
80-680-04	grün / green
80-680-05	gelb / yellow
80-680-06	lila / purple
80-680-07	blau / blue

### Zubehör

Accessories

- 80-683-00 **Container-Siegel, disposable, blau, 500 Stück / Box**  
Container seal, disposable, blue, 500 pieces / box
- 80-684-00 **Indikator-Klebe-Etikett, Lasche rechts, 1000 Stück / Box**  
Adhesive indicator label, latch right side, 1000 pieces / box
- 80-685-00 **Entsorgungsmarke, Edelstahl, zum Aufstecken, 2,5 x 3 cm, inclusive Gravur bis zu 5 Zeichen**  
Clip on coding clamp, stainless steel, 2.5 x 3 cm, including engraving up to 5 characters
- 80-688-00 **Klemmschild aus Edelstahl, 6 x 4 cm, 25 Stück / Box**  
Stainless steel label, 6 x 4 cm, 25 pieces / box

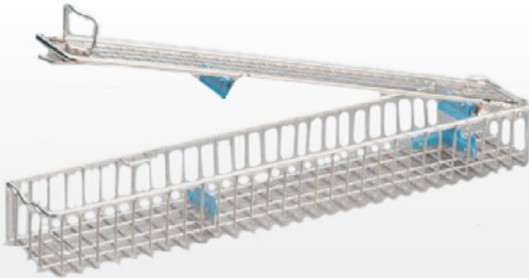

**Endoskopie-Siebkorb mit Deckel,  
Edelstahl, epoliert**  
Endoscope container with lid,  
stainless steel, e-polished

- 80-690-01 für 1 Endoskop / for 1 endoscope,  
29,0 x 8,0 x 5,2 cm
- 80-690-02 für 2 Endoskope / for 2 endoscopes,  
29,0 x 8,0 x 5,2 cm



**Endoskopie-Siebkorb mit Deckel,  
Edelstahl, epoliert**  
Endoscope container with lid,  
stainless steel, e-polished

- 80-691-01 für 1 Endoskop / for 1 endoscope,  
46,0 x 8,0 x 5,2 cm
- 80-692-01 für 1 Endoskop / for 1 endoscope,  
67,0 x 8,0 x 5,2 cm

## Sets

## 20-905-00 Premium Rhinoplastik-Set

### Premium Rhinoplasty set

Bestehend aus / Consisting of:

- a) 20-425-02 **Osteotom Premium Line, 2 mm, 18 cm, vergoldeter Griff**  
Osteotome premium line, 2 mm, 18 cm, golden handle
- b) 20-425-03 **Osteotom Premium Line, 3 mm, 18 cm, vergoldeter Griff**  
Osteotome premium line, 3 mm, 18 cm, golden handle
- c) 20-425-06 **Osteotom Premium Line, 6 mm, 18 cm, vergoldeter Griff**  
Osteotome premium line, 6 mm, 18 cm, golden handle
- d) 20-425-10 **Osteotom Premium Line, 10 mm, 18 cm, vergoldeter Griff**  
Osteotome premium line, 10 mm, 18 cm, golden handle
- e) 20-425-12 **Osteotom Premium Line, 12 mm, 18 cm, vergoldeter Griff**  
Osteotome premium line, 12 mm, 18 cm, golden handle
- f) 20-425-14 **Osteotom Premium Line, 14 mm, 18 cm, vergoldeter Griff**  
Osteotome premium line, 14 mm, 18 cm, golden handle
- g) 20-425-25 **Osteotom Premium Line, 2,5 mm, 18 cm, vergoldeter Griff**  
Osteotome premium line, 2.5 mm, 18 cm, golden handle
- h) 20-426-00 **Osteotom Premium Line, mit Schutzsonde, 2,2 mm, 18 cm, vergoldeter Griff**  
Osteotome, premium line, guarded, 2.2 mm, 18 cm, golden handle
- i) 20-579-04 **Cottle Doppel-Haken, beidseitig scharf, extra fein, 10 mm, 12 cm, vergoldeter Griff**  
Cottle double hook, both prongs sharp, very fine, 10 mm, 12 cm, golden handle
- k) 20-588-01 **Wundhäkchen, superfein, 1-zinkig, 16 cm, vergoldeter Griff**  
Skin hook, very fine, 1 prong, 16 cm, golden handle
- l) 20-588-02 **Wundhäkchen, superfein, 2-zinkig, 16 cm, vergoldeter Griff**  
Skin hook, very fine, 2 prongs, 16 cm, golden handle
- m) 20-568-16 **Nasenrückenhaken, extra fein, 45 mm, 16 cm, vergoldeter Griff**  
Aufrecht nasal retractor, extra fine, 45 mm, 16 cm, golden handle
- n) 10-532-12 **Schere, Hartmetall, spitz-spitz, gerade, 11,5 cm, vergoldeter Griff**  
Scissors, tungsten carbide, straight, pointed, 11.5 cm, golden handle

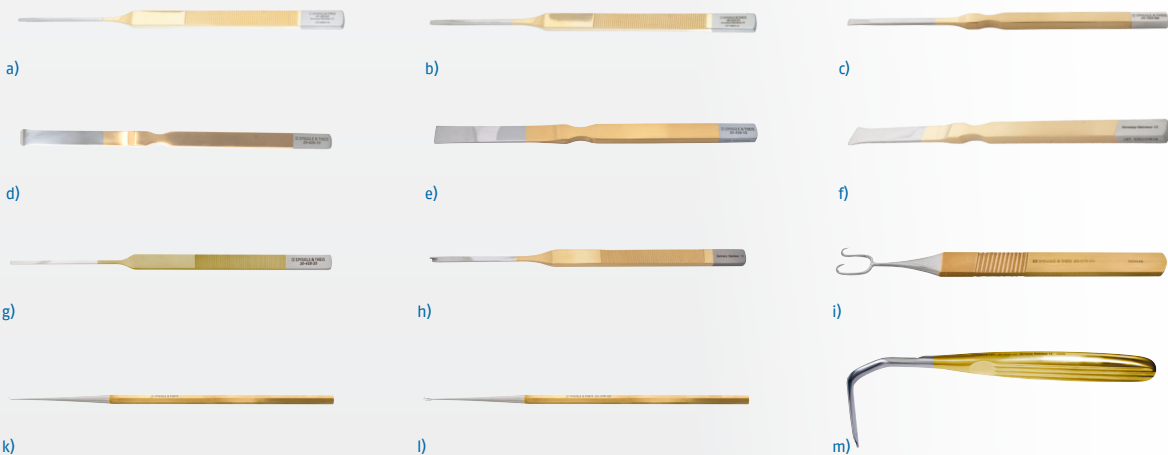



**20-905-00 Premium Rhinoplastik-Set**  
Premium Rhinoplasty set

- o) 10-535-12 Schere, Hartmetall, sp-sp, gebogen, 11,5 cm, vergoldeter Griff  
Scissors, TC, curved, pointed, 11.5 cm, golden handle
- p) 20-631-10 Walter Schere, gewinkelt, 10 cm, vergoldeter Griff  
Walter scissors, angled, 10 cm, golden handle
- q) 20-713-12 Adson-Brown-Pinzette, Hartmetall, 7:8 Zähne, 12 cm, vergoldeter Griff  
Adson dressing forceps, TC, 7:8 teeth, 12 cm, golden handle
- r) 10-496-12 Adson-Pinzette, Hartmetall, anatomisch, 12 cm, vergoldeter Griff  
Adson dressing forceps, TC, anatomical, 12 cm, golden handle
- s) 20-714-12 Adson-Pinzette, Hartmetall, 1:2 Zähne, 12 cm, vergoldeter Griff  
Adson dressing forceps, TC, 1:2 teeth, 12 cm, golden handle
- t) 20-215-01 Blakesley Nasenzange, gerade, Gr. 1 (3,5 mm), 11,5 cm, vergoldeter Griff  
Blakesley nasal forceps, Size 1 (3.5mm), 11.5 cm, straight, golden handle
- u) 20-622-13 Rhinoplastik Schere, Hartmetall, flache Spitze, stumpf, gebogen, 12,5 cm, vergoldeter Griff  
Rhinoplasty scissors, TC, flat end, blunt, curved, 12.5 cm, golden handle
- v) 10-555-13 Nadelhalter, Hartmetall, fein, 13 cm, vergoldeter Griff  
Halsey needle holder, TC, delicate, 13 cm, golden handle
- w) 20-825-18 Aufricht Glabella Rassel, einseitig, auf Zug und Druck, 18 cm, vergoldeter Griff  
Aufricht Glabella rasp, single ended, up and down cutting, 18 cm, golden handle
- x) 10-353-13 Raspatorium, gerade, 17 cm, vergoldeter Griff  
Raspatory, straight, 17 cm, golden handle
- y) 20-801-03 Fomon Nasenraspel, Hartmetall, doppelseitig, Körnung 5/6 (mittel), 20 cm, vergoldeter Griff  
Fomon nasal rasp, TC, double ended, grain size 5/6 (medium), 20 cm, golden handle
- z) 20-801-04 Fomon Nasenraspel, Hartm., doppelseitig, Körnung 7/8 (mittel/fein), 20 cm, vergoldeter Griff  
Fomon nasal rasp, TC, double ended, grain size 7/8 (medium/fine), 20 cm, golden handle



n)



o)



p)



q)



r)



s)

**Das SPIGGLE & THEIS**  
Premium Rhinoplastik Set  
- Instrumente für höchste Ansprüche an Qualität und Ergonomie

**The SPIGGLE & THEIS**  
Premium Rhinoplasty Set  
- Sophisticated Instruments to meet highest expectations towards quality and ergonomoy



t)



u)



v)



w)



x)



y)



z)

## Sets

## 20-900-00 Rhinoplastik-Set

### Rhinoplasty set

Bestehend aus / Consisting of:

10-302-35	Saugrohr, kniegebogen, konisch, 2x	Suction tube, angled, conical, 2x
10-300-25	Saugrohr, kniegebogen, zylindrisch, 2x	Suction tube, angled, cylindrical, 2x
10-360-03	Skalpell-Griff	Scalpel handle
10-360-11	Skalpell-Klingen Nr. 11	Scalpel blades No. 11
10-360-15	Skalpell-Klingen Nr. 15	Scalpel blades No. 15
20-550-10	Mikro Handgriff	Micro handle
20-551-64	Mikro-Klingen SM64	Micro blades SM64
20-551-65	Mikro-Klingen SM65	Micro blades SM65
20-500-13	Cottle Septum-Messer	Cottle septum knife
20-501-14	Masing Ritzmesser	Masing pointed knife
20-800-16	Watteträger	Cotton carrier
20-601-14	Joseph Schere	Joseph scissors
20-610-15	Reynolds Schere	Reynolds scissors
20-615-15	Metzenbaum Schere	Metzenbaum scissors
20-627-13	Goldman Fox Schere	Goldman Fox scissors
20-630-10	Walter Schere	Walter scissors
20-632-12	Cottle Nasenflügelschere	Cottle lower lateral scissors
20-560-15	Cottle Nasenflügelhaken	Cottle alar retractor
20-569-16	Aufricht Nasenrückenhaken mit Fiberglas Lichtträger	Aufricht nasal retractor with fibre light carrier
20-570-13	Aufricht Doppelhaken	Aufricht double retractor
20-574-06	Cottle Fingerring-Häkchen	Cottle thimble hook
20-577-16	Cottle Hauthäkchen	Cottle skin hook
20-579-01	Cottle Doppel-Haken rechts geknöpft	Cottle double hook, right prong blunt
20-579-02	Cottle Doppel-Haken links geknöpft	Cottle double hook, left prong blunt
20-700-10	Cottle Columella-Klemme	Cottle columella forceps
20-710-12	Adson-Brown Pinzette	Adson-Brown forceps
20-705-14	Herberhold Hautfazzange	Herberhold tissue forceps
20-720-14	Cottle Nasenpinzette	Cottle lower lateral forceps
20-730-16	Jansen Nasenpinzette	Jansen nasal forceps
20-199-05	Saugrohr mit abgeflachtem Ende	Suction tube with flattened end
10-302-35	Saugrohr, kniegebogen, konisch	Suction tube, angled, conical
10-300-25	Saugrohr, kniegebogen, zylindrisch	Suction tube, angled, cylindrical
20-322-01	Guillen Saugraspatorium	Guillen suction raspatory
20-300-21	Masing Elevatorium/Raspatorium	Masing elevator/raspatory
20-305-18	Freer Doppellevatorium	Freer elevator, double ended
20-318-04	McKenty Raspatorium, stark gebogen	McKenty raspatory, strongly curved
20-312-23	Cottle Tunnel-Raspatorium, doppelseitig	Cottle tunneling raspatory, double ended
20-100-01	Hartmann Nasentamponadezange	Hartmann nasal dressing forceps
20-152-55	Herberhold Septum-Spekulum, 55 mm	Herberhold septum speculum, 55 mm
20-152-75	Herberhold Septum-Spekulum, 75 mm	Herberhold septum speculum, 75 mm
20-152-90	Herberhold Septum-Spekulum, 90 mm	Herberhold septum speculum, 90 mm
20-215-00	Blakesley Nasenzange Premium, gerade, 3,0 mm	Blakesley Premium nasal forceps, straight, 3.0 mm
20-215-02	Blakesley Nasenzange Premium, gerade, 4,0 mm	Blakesley Premium nasal forceps, straight, 4.0 mm
20-225-01	Blakesley Nasenzange Premium, 45°, aufgebogen	Blakesley Premium nasal forceps, 45° upcurved
20-270-19	Kazanjian Knochenzange	Kazanjian rongeur
20-287-23	Cottle-Walsham Septum-Richtzange	Cottle-Walsham septum straightening forceps
20-400-18	Cottle Hammer	Cottle mallet
20-865-30	Cottle Knochen- und Knorpelquetscher	Cottle bone- and cartilage crusher
20-425-02	Osteotom Premium Line, 2 mm	Osteotome Premium Line, 2 mm
20-425-03	Osteotom Premium Line, 3 mm	Osteotome Premium Line, 3 mm
20-425-06	Osteotom Premium Line, 6 mm	Osteotome Premium Line, 6 mm
20-425-12	Osteotom Premium Line, 12 mm	Osteotome Premium Line, 12 mm
20-435-02	Herberhold Osteotom zur lateralen Osteotomie, links	Herberhold osteotome for lateral osteotomy, left
20-435-03	Herberhold Osteotom zur lateralen Osteotomie, rechts	Herberhold osteotome for lateral osteotomy, right
20-801-02	Fomon Nasenraspel Größe 3/4	Fomon nasal rasp, size 3/4
20-801-05	Fomon Nasenraspel Größe 9/10	Fomon nasal rasp, size 9/10
20-810-21	Fomon Nasenraspel, Diamant, goldener Griff	Fomon nasal rasp, diamond, golden handle
20-808-00	Aufricht Glabella Rasper, Hartmetall	Aufricht glabella rasp, tungsten carbide
20-740-15	Crile-Wood Nadelhalter	Crile-Wood needleholder
20-744-17	Senning Nadelhalter, extra schlank	Senning needle holder, slender shape
20-856-17	Joseph Anlegeinstrument zur Rhinoplastik, gewinkelt	Joseph placing instrument for rhinoplasty, angled
20-852-07	Castroviejo Nasenzirkel, 20 mm-Skala	Castroviejo nasal caliper, 20 mm scale
80-018-45	Bipolares Anschlusskabel, 4 m	Bipolar connection cable, 4 m
80-111-16	Non Stick Bipolare Pinzette	Bipolar forceps
80-503-03	Medizinbecher, graduert, 30 ml, 2x	Medical cup, graduated, 30 ml, 2x
80-504-04	Medizinbecher, graduert, 50 ml, 2x	Medical cup, graduated, 50 ml, 2x



## 20-901-00 Septum-Set Septum set

Bestehend aus / Consisting of:

20-100-01	Hartmann Nasenspekulum	Hartmann nasal speculum
20-152-55	Herberhold Septum-Spekulum, extra fein, 55 mm	Herberhold septum speculum, extra fine, 55 mm
20-152-75	Herberhold Septum-Spekulum, extra fein, 75 mm	Herberhold septum speculum, extra fine, 75 mm
20-190-25	Krause Nasen-Polypen-Schnürer, scharf	Krause nasal polyp snare, sharp
20-195-35	Nasenpolypenschlingen, 0,35 mm, 100 Stück	Nasal snare wires, 0.35 mm, 100 pieces
20-201-20	Hartmann Nasentamponadezange	Hartmann nasal dressing forceps
20-215-01	Blakesley Nasenzange Premium, 3,5 mm, gerade	Blakesley premium nasal forceps, 3.5 mm, straight
20-215-03	Blakesley Nasenzange Premium, 5 mm, gerade	Blakesley premium nasal forceps, 5 mm, straight
20-225-02	Blakesley Nasenzange Premium, 45° aufgebogen	Blakesley premium nasal forceps, 45° upcurved
20-259-00	Craig-Domnick Septum-Zange, scharf	Craig-Domnick septum forceps, sharp
20-300-21	Masing Elevatorium/Raspatorium	Masing elevator/raspatory
20-305-18	Freer Doppelelevatorium, scharf/stumpf	Freer elevator, double ended, sharp/blunt
20-322-01	Guillen Saugraspatorium	Guillen suction raspatory
20-318-05	McKenty Raspatorium, stark gebogen	McKenty raspatory, strongly curved
20-312-23	Cottle Tunnel-Raspatorium, doppelseitig	Cottle tunneling raspatory, double ended
20-400-18	Cottle Hammer	Cottle mallet
20-405-04	Cottle Meißel, 4 mm	Cottle chisel, 4 mm
20-405-07	Cottle Meißel, 7 mm	Cottle chisel, 7 mm
20-409-06	Cottle Meißel, flach, gebogen, 6 mm	Cottle chisel, flat, curved, 6 mm
20-500-13	Cottle Septum-Messer	Cottle septum knife
20-501-14	Masing Ritzmesser	Masing pointed knife
20-560-15	Cottle Nasenflügelhaken	Cottle alar retractor
20-569-16	Aufricht Nasenrückenhaken mit Fiberglas Lichtträger	Aufricht nasal retractor with fibre light carrier
20-601-14	Joseph Schere	Joseph scissors
20-615-15	Metzenbaum Schere	Metzenbaum scissors
20-630-10	Walter Schere	Walter scissors
20-680-16	Heymann Nasenschere, gezahnt	Heymann nasal scissors, toothed
20-700-10	Cottle Columella-Klemme, 11 cm, 2x	Cottle columella forceps, 11 cm
20-710-12	Adson-Brown Pinzette, 2x	Adson-Brown forceps, 2x
20-720-14	Cottle Nasenpinzette	Cottle lower lateral forceps, 2x
20-730-16	Jansen Nasenpinzette	Jansen nasal forceps
10-480-14	Pinzette, anatomisch, gerade	Dressing forceps, anatomical, straight
10-483-14	Pinzette, chirurgisch, 1:2 Zähne	Dressing forceps, 1:2 teeth, straight
20-740-15	Crile-Wood Nadelhalter	Crile-Wood needleholder
20-800-16	Watteträger, ø 1,2 mm, 5 Stück	Cotton carrier, ø 1.2 mm, 5 pieces
20-850-20	Aufricht Nasenfraktur-Elevatorium	Aufricht nasal fracture elevator,
10-302-30	Saugrohr, kniegebogen, konisch	Suction tube, angled, conical
10-300-40	Saugrohr, kniegebogen, zylindrisch	Suction tube, angled, cylindrical
10-550-13	Universalschere, gebogen, spitz-stumpf	Universal scissors, curved, sharp-blunt
30-104-12	Frazier Saugrohr, kniegebogen	Frazier suction tube, angled
80-018-45	Bipolares Anschlusskabel, 4 m	Bipolar connection cable, 4 m
80-111-16	Non Stick Bipolare Pinzette	Bipolar forceps
80-503-03	Medizinbecher, graduert, 30 ml, 2x	Medical cup, graduated, 30 ml, 2x
80-504-05	Medizinbecher, graduert, 50 ml, 2x	Medical cup, graduated, 50 ml, 2x







Numerical Index

20-632-12 ..... 48	20-804-10 ..... 56	30-160-01 ..... 8	80-670-49 ..... 66
20-633-12 ..... 47	20-804-20 ..... 56	30-160-02 ..... 8	80-680-01 ..... 66
20-635-13 ..... 48	20-804-99 ..... 56	30-160-03 ..... 8	80-680-02 ..... 66
20-638-16 ..... 48	20-805-01 ..... 57	30-169-08 ..... 10	80-680-03 ..... 66
20-639-16 ..... 48	20-805-02 ..... 57	30-170-28 ..... 9	80-680-04 ..... 66
20-680-16 ..... 49	20-806-01 ..... 57	30-170-36 ..... 9	80-680-05 ..... 66
20-681-16 ..... 49	20-806-02 ..... 57	30-171-40 ..... 9	80-680-06 ..... 66
20-682-16 ..... 49	20-808-00 ..... 57	30-182-21 ..... 8	80-680-07 ..... 66
20-683-18 ..... 49	20-810-21 ..... 58	30-320-01 ..... 25	80-683-00 ..... 66
20-690-01 ..... 49	20-811-19 ..... 58	30-320-02 ..... 25	80-684-00 ..... 66
20-690-02 ..... 49	20-812-19 ..... 58	30-321-01 ..... 25	80-685-00 ..... 66
20-690-03 ..... 49	20-815-21 ..... 58	30-321-02 ..... 25	80-688-00 ..... 66
20-691-01 ..... 49	20-816-21 ..... 58	30-322-01 ..... 25	80-690-01 ..... 67
20-695-11 ..... 49	20-818-18 ..... 58	30-322-02 ..... 25	80-690-02 ..... 67
20-696-11 ..... 49	20-819-18 ..... 58	30-700-00 ..... 14	80-691-01 ..... 67
20-697-11 ..... 49	20-820-21 ..... 58	30-700-01 ..... 14	80-692-01 ..... 67
20-700-10 ..... 50	20-822-21 ..... 59	30-711-00 ..... 14	
20-701-08 ..... 50	20-823-21 ..... 59	70-211-00 ..... 8	
20-705-14 ..... 50	20-824-21 ..... 59	70-211-01 ..... 8	
20-710-12 ..... 50	20-825-18 ..... 59	70-211-10 ..... 8	
20-711-12 ..... 50	20-826-21 ..... 59	70-211-20 ..... 8	
20-712-12 ..... 51	20-827-21 ..... 59	70-211-30 ..... 8	
20-713-12 ..... 51	20-828-16 ..... 59	70-211-40 ..... 8	
20-714-12 ..... 51	20-829-16 ..... 59	70-211-50 ..... 8	
20-715-12 ..... 51	20-830-21 ..... 59	80-016-50 ..... 62	
20-716-12 ..... 52	20-850-20 ..... 60	80-017-30 ..... 63	
20-718-11 ..... 53	20-851-18 ..... 60	80-017-50 ..... 63	
20-720-14 ..... 54	20-852-07 ..... 60	80-018-30 ..... 63	
20-722-15 ..... 52	20-853-03 ..... 60	80-018-50 ..... 63	
20-730-16 ..... 18	20-853-04 ..... 60	80-019-30 ..... 63	
20-730-19 ..... 18	20-856-17 ..... 61	80-019-50 ..... 63	
20-740-15 ..... 54	20-857-00 ..... 61	80-020-30 ..... 63	
20-742-13 ..... 54	20-860-01 ..... 61	80-020-50 ..... 63	
20-744-15 ..... 55	20-860-02 ..... 61	80-022-30 ..... 63	
20-744-17 ..... 55	20-860-03 ..... 61	80-022-50 ..... 63	
20-745-15 ..... 55	20-865-30 ..... 61	80-101-16 ..... 62	
20-746-12 ..... 55	20-865-50 ..... 61	80-106-16 ..... 62	
20-748-10 ..... 54	20-867-40 ..... 62	80-111-16 ..... 62	
20-748-11 ..... 54	20-868-40 ..... 62	80-501-01 ..... 64	
20-748-13 ..... 54	20-900-00 ..... 70	80-501-02 ..... 64	
20-760-11 ..... 55	20-901-00 ..... 71	80-501-03 ..... 64	
20-760-14 ..... 55	20-905-00 ..... 68, 69	80-501-04 ..... 64	
20-761-14 ..... 55	30-103-06 ..... 19	80-503-03 ..... 64	
20-800-16 ..... 18	30-103-07 ..... 19	80-504-05 ..... 64	
20-801-00 ..... 56	30-103-08 ..... 19	80-506-30 ..... 64	
20-801-01 ..... 56	30-103-09 ..... 19	80-507-40 ..... 64	
20-801-02 ..... 56	30-103-10 ..... 19	80-509-75 ..... 64	
20-801-03 ..... 56	30-103-12 ..... 19	80-512-00 ..... 64	
20-801-04 ..... 56	30-103-15 ..... 19	80-515-06 ..... 64	
20-801-05 ..... 56	30-105-06 ..... 19	80-515-08 ..... 64	
20-801-16 ..... 18	30-105-08 ..... 19	80-515-10 ..... 64	
20-802-16 ..... 18	30-105-10 ..... 19	80-517-00 ..... 64	
20-803-01 ..... 57	30-130-00 ..... 7	80-519-00 ..... 65	
20-803-02 ..... 57	30-130-30 ..... 7	80-519-01 ..... 65	
20-803-03 ..... 57	30-130-70 ..... 7	80-519-02 ..... 65	
20-803-04 ..... 57	30-131-00 ..... 6	80-519-03 ..... 65	
20-803-05 ..... 57	30-131-30 ..... 6	80-520-06 ..... 65	
20-803-06 ..... 57	30-132-00 ..... 7	80-520-08 ..... 65	
20-803-07 ..... 57	30-132-30 ..... 7	80-525-17 ..... 65	
20-803-08 ..... 57	30-132-45 ..... 7	80-525-25 ..... 65	
20-804-00 ..... 56	30-134-00 ..... 7	80-528-13 ..... 65	
20-804-01 ..... 56	30-134-30 ..... 7	80-528-18 ..... 65	
20-804-02 ..... 56	30-134-45 ..... 7	80-528-20 ..... 65	
20-804-03 ..... 56	30-134-70 ..... 7	80-530-20 ..... 65	
20-804-04 ..... 56	30-135-00 ..... 6	80-630-12 ..... 66	
20-804-05 ..... 56	30-135-30 ..... 6	80-650-00 ..... 62	
20-804-06 ..... 56	30-142-00 ..... 6	80-660-14 ..... 66	
20-804-07 ..... 56	30-142-30 ..... 6	80-660-21 ..... 66	
20-804-08 ..... 56	30-142-45 ..... 6	80-670-25 ..... 66	
20-804-09 ..... 56	30-142-70 ..... 6	80-670-40 ..... 66	



Adson Pinzetten.....	50-51	Freer Wundhäkchen.....	40	Neivert Draht-Doppelhaken.....	38
Adson-Brown Pinzette .....	50, 51	Gelenkkloben.....	14	Neivert Nadelhalter .....	54
Anderson Nasenraspel.....	59	Gillies Gewebepinzette.....	52	Nierenschale, Edelstahl .....	65
Anderson-Neivert Osteotom .....	35	Gillies Hauthäkchen.....	41	Noyes Nasentamponadezange.....	17
Ash Septum-Richtzange.....	26	Glatzel Nasenspiegel .....	18	Ölspray .....	62
Aufricht Doppelhaken .....	39	Goldman-Fox Schere.....	45	Osteotom Premium Line.....	33
Aufricht Glabella Raspel.....	57, 59	Graefe Mäusezähnnchen Pinzette .....	53	Parkes Nasenraspel.....	57
Aufricht Haken für flexiblen Spannarm.....	14	Graefe Pinzetten .....	52, 53	Petrischale.....	64
Aufricht Nasenfraktur-Elevatorium .....	60	Rubin Knorpelquetschzange .....	25	Pinzette, anatomisch .....	50-53
Aufricht Nasenrückenhaken.....	39	Guillen Saugraspatorium.....	29	Pinzette, chirurgisch .....	50-53
Ballenger-Messer .....	60	Hajek Metallhammer .....	30	Porzellanschälchen.....	65
Beckmann Nasenspekulum.....	12	Halsey Nadelhalter .....	54	Premium Rhinoplastik-Set .....	68-69
Bipolare Pinzette, Non-Stick .....	62	Hammer mit Alugriff und Metallkopf .....	30	Raspatorium, gerade.....	28
Bipolares Anschlusskabel .....	62, 63	Handgriff mit Raspelplatten .....	56	Raspeleinsätze .....	56
Blakesley Nasenzangen .....	20, 21	Hartmann Conchotom .....	24	Reynolds Scheren .....	42, 43
Boies Elevatorium .....	60	Hartmann Nasenspekulum .....	11	Rhinoplastik-Set.....	70
Brünings Messer .....	37	Hartmann Nasentamponadezange .....	16	Rowland Nasenzange.....	23
Caplan Nasenschere .....	24	Hartmann-Halle Nasenspekulum.....	11	Rubin Knorpelquetschzange .....	25
Castroviejo Mikro-Gefäß-Nadelhalter.....	55	Herberhold Hautfazzange .....	50	Rubin Osteotome .....	32
Castroviejo Nasenzirkel.....	60	Herberhold Osteotom .....	34	Saugrohre.....	18, 19
Cinelli Osteotom.....	32	Herberhold Septum-Spekulum .....	13	Schere, gerade.....	42-47
Conchotomie Schere, gezahnt .....	49	Heymann Nasenschere .....	49	Schere, Hartmetall.....	42-46
Codier-Schild .....	66	Jameson Profilometer .....	61	Schere, spitz-spitz.....	42-47
Converse Nadelhalter .....	55	Jansen Nasenpinzette .....	18	Schere, supercut .....	42-46
Converse Nasenflügel-Doppelhaken .....	38	Joseph Doppel-Häkchen .....	41	Schmeden Conchotom .....	25
Cottle Columella-Klemme .....	50	Joseph Anlegeinstrument.....	61	Schuknecht Drahtschneidescherchen .....	47
Cottle Doppel-Haken .....	40	Joseph Nasenraspel .....	59	Schutzhülse für Knorpelquetschzange.....	25
Cottle Elevatorium / Raspatorium .....	28	Joseph Nasensäge .....	61	Selbsthaltendes Spekulum .....	14
Cottle Fingerring-Häkchen .....	39	Joseph Rhinoplastikmesser.....	37	Senning Nadelhalter .....	55
Cottle Hammer .....	30	Joseph Schere.....	42	Septum-Set .....	71
Cottle Hauthäkchen .....	40, 41	Kabierske Kanüle .....	17	Siebkorb .....	66
Cottle Knochen- und Knorpelquetscher.....	61	Kabierske Pulverbläser .....	17	Sinuskope .....	5-7
Cottle Meißel.....	31	Kazanjan Kochenzange.....	23	Skalpell-Griff .....	36
Cottle Nasenflügelhaken .....	38	Killian Septum-Spekulum .....	12, 13	Skalpell-Klingen .....	36
Cottle Nasenflügelschere .....	48	Killian Raspatorium, doppelseitig .....	27	Stevens Gefäßschere .....	45
Cottle Nasenhaken .....	38	Killian-Claus Hohlmeißel .....	34	Strümpel-Voss Nasenzange .....	21
Cottle Nasenpinzette .....	54	Killian-Struycken Septum-Spekulum .....	12	Struycken Nasenzange.....	24
Cottle Nasenraspel .....	58	Kilner Rhinoplastikschere.....	44	Tablettenschale .....	64
Cottle Nasenschere .....	48	Kilner Wundhäkchen.....	39	Takahashi Nasenzange .....	21
Cottle Osteotom mit Führungsdorn .....	34	Kleinert-Kutz Nasenraspel.....	59	Tieck-Halle Nasenspekulum.....	11
Cottle Osteotom, 2 Führungsdorne .....	32	Kornzangenbehälter .....	65	Tolsdorff Knochen- u. Knorpelquetscher .....	62
Cottle Osteotom, flach .....	31	Krause Nasen-Polypen-Schnürer .....	15	Ultra-Stop Antibeschlagmittel .....	8
Cottle Raspatorium .....	27, 28	Krause-Voss Nasen-Polypen-Schnürer .....	15	Ulmer Raspatorium.....	29
Cottle Septum-Messer .....	36	Kressner Muschelquetschzange.....	26	Universalschere, gebogen.....	47
Cottle Septum-Spekula .....	12-14	Lange Nasen-Polypen-Schnürer .....	15	Walter Hohlmeißel .....	34
Cottle Tunnel-Raspatorium.....	28	LED-Leuchtgriffe .....	8	Walter Osteotom .....	33
Cottle-Neivert Doppelhaken .....	38	Lempert Raspatorium.....	28	Walter Schere .....	47
Cottle-Walsham Septum-Richtzange .....	26	Lister Nasentamponadezange .....	16	Watson-Williams Nasenzange .....	22
Craig Septum-Zange.....	23	Lösungsschale .....	64	Watteträger.....	18
Craig-Domnick Septum-Zange.....	23	Maltz Nasenraspel .....	57, 58	Weber Doppellevatorium .....	27
Crile-Wood Nadelhalter .....	54	Masing Elevatorium/Raspatorium .....	27	Weber Nasenschere .....	49
DeBaKey Pinzette .....	52	Masing Nadelhalter .....	54	Westmacott Nasentamponadezange .....	16
Dichtigkeitstester .....	10	Masing Nasenraspel .....	58	Wigand Polypen-Fasszange .....	21
Durchschneidende Nasenzange.....	25	Masing Osteotome .....	34, 35	Wundhäkchen, superfein.....	41
Endoskope.....	5 - 7	Masing Ritzmesser .....	36	Wullstein Raspatorium .....	29
Endoskop-Schutzhülse .....	8	McKenty Raspatorien.....	27, 29	Wurm Osteotom .....	35
Endoskopie Siebkorb .....	67	Medikamentenschälchen mit Deckel.....	64	Yankauer Septumnadel.....	41
Ertsatzbacken für Metallhammer .....	30	Medikamentenschälchen, Dappenglas .....	65	Ziehstange für Nasen-Polypen-Schnürer .....	15
Ferris-Smith Nasenzange .....	22	Medizinbecher .....	64	Zubehör .....	66
Flexibler Spannarm .....	14	Metallhammer .....	30		
Flexibles Endoskop .....	9	Metallschale .....	64		
Fomon Nasenflügelhaken.....	40	Metzenbaum Scheren.....	43, 44		
Fomon Nasenraspel .....	56	Mikro-Adson-Pinzette.....	51, 52		
Fomon Nasenraspel, Diamant .....	58	Mikro-Gefäßschere .....	49		
Fomon Nasenscheren .....	47, 48	Mikro-Handgriff.....	37		
Frazier Saugrohr.....	19	Mikro-Klingen .....	37		
Freer Doppellevatorium.....	27	Mikro-Ryder Nadelhalter .....	55		
Freer Golfstock-Raspatorium.....	27	Miller Nasenraspel.....	57		
Freer-Joseph Doppel-Raspatorium.....	28	Mini Osteotom.....	33		
Freer Raspatorium.....	29	Nasensonde.....	28		
Freer Septum Messer.....	36	Nasenpolypenschlingen.....	15		





Accessories .....	66	Gillies skin hook .....	41	Osteotomes.....	31-35
Adson forceps.....	50-51	Gillies tissue forceps .....	52	Osteotome Premium Line .....	33
Adson-Brown forceps.....	50,51	Glatzel nasal mirror .....	18	Parkes nasal rasp .....	57
Anderson nasal rasp .....	59	Goldman-Fox scissors .....	45	Petri dish .....	64
Anderson-Neivert osteotome .....	35	Graefe forceps .....	52, 53	Premium Rhinoplasty Set .....	68-69
Ash septum straightening forceps .....	26	Guillen suction raspatory .....	29	Raspatory.....	28
Aufricht double hook .....	39	Hajek metal mallet.....	30	Reynolds scissors .....	42, 43
Aufricht glabella rasp .....	57, 59	Halsey needle holder .....	54	Rhinoplasty set.....	70
Aufricht hook for flexible holding arm .....	14	Handle for rasps .....	56	Rotation clamp .....	14
Aufricht nasal fracture elevator.....	60	Hartmann cutting forceps .....	24	Rowland nasal forceps .....	23
Aufricht nasal retractors.....	39	Hartmann nasal sponge holding forceps.....	16	Rubin morcelizer forceps.....	25
Basket .....	66	Hartmann nasal speculum .....	11	Rubin osteotome .....	32
Ballenger knife.....	60	Hartmann-Halle nasal speculum .....	11	Scalpel blades.....	36
Beckmann nasal speculum .....	12	Herberhold osteotome .....	34	Scalpel handle.....	36
Bipolar connection cable .....	62, 63	Herberhold septum speculum .....	13	Schmeden conchotome .....	25
Bipolar forceps .....	62	Herberhold tissue forceps .....	50	Schuknecht wire cutting scissors.....	47
Blakesley nasal forceps.....	20, 21	Heymann nasal scissors .....	49	Scissors, pointed .....	42-47
Boies Elevator .....	60	Insert for rasp .....	56	Scissors, straight .....	42-47
Brünings knife.....	37	Jameson caliper .....	61	Scissors, supercut.....	42-46
Caplan nasal scissors.....	24	Jansen nasal forceps.....	18	Scissors, tungsten carbide .....	42-46
Castroviejo micro vascular needle holder .....	55	Joseph double hook .....	41	Self holding speculum with set screw .....	14
Castroviejo nasal caliper .....	60	Joseph placing instrument .....	61	Senning needle holder.....	55
China bowl .....	65	Joseph nasal rasp .....	59	Septum set .....	71
Cinelli osteotome .....	32	Joseph nasal saw .....	61	Sinusscopes .....	5-8
Coding label .....	66	Joseph rhinoplasty knife .....	37	Skin hook.....	41
Conchotomy scissors .....	49	Joseph scissors .....	42	Solution bowl.....	64
Converse alar double hook .....	38	Kabierske cannula.....	17	Sleeve for rubin morcelizer forceps.....	25
Converse needle holder .....	55	Kabierske powder blower.....	17	Spare nylon facings .....	30
Cotton carrier .....	18	Kazanjian rongueur .....	23	Special oil spray .....	62
Cottle alar retractor.....	38	Kidney bowl.....	65	Stevens vascular scissors .....	45
Cottle bone- and cartilage crusher .....	61	Killian raspatory, double ended.....	27	Strümpel-Voss nasal forceps .....	21
Cottle chisel .....	31	Killian-Claus gouge .....	34	Struycken nasal forceps .....	24
Cottle columella forceps.....	50	Killian septum speculum .....	12, 13	Stylet for nasal snares .....	15
Cottle double hook.....	40	Killian-Struycken nasal speculum .....	12	Suction tubes .....	18, 19
Cottle lower lateral forceps .....	54	Kilner hook.....	39	Tablet dish .....	64
Cottle lower lateral scissors.....	48	Kilner rhinoplasty scissors .....	44	Takahashi nasal forceps .....	21, 22
Cottle mallet .....	30	Kleinert-Kutz nasal rasp .....	59	Tieck-Halle nasal speculum .....	11
Cottle nasal hook .....	38	Krause nasal polyp snare .....	15	Tolsdorff bone- and cartilage crusher .....	62
Cottle nasal rasp .....	58	Krause-Voss nasal polyp snare .....	15	Ulmer raspatory .....	29
Cottle nasal scissors .....	48	Kressner turbinate crushing forceps.....	26	Ultra-Stop Anti-Fog solution.....	8
Cottle osteotome.....	31 - 34	Lange nasal polyp snare .....	15	Universal scissors .....	47
Cottle raspatory .....	28	Leak tester .....	10	Watson-Williams nasal forceps.....	22
Cottle septum knife .....	36	Lempert raspatory .....	28	Walter gouge.....	34
Cottle septum speculum .....	12-14	LED-light handles .....	8	Walter osteotome.....	33
Cottle skin hook .....	40, 41	Lister nasal sponge holding forceps.....	16	Walter scissors.....	47
Cottle thimble hook.....	39	Mallets .....	30	Weber elevator, double ended .....	27
Cottle tunnel raspatory .....	28	Maltz nasal rasp.....	57, 58	Weber nasal scissors .....	49
Cottle-Neivert double hook .....	38	Masing elevator/raspatory .....	27	Westmacott nasal dressing forceps .....	16
Cottle-Walsham septum straightening forceps .....	26	Masing nasal rasp .....	58	Wigand polyp-grasping forceps .....	21
Craig septum forceps .....	23	Masing needle holder .....	54	Wullstein raspatory.....	29
Craig-Domnick septum forceps .....	23	Masing osteotome .....	34, 35	Wurm osteotome .....	35
Crile-Wood needle holder .....	54	Masing pointed knife.....	36	Yankauer septum needle .....	41
DeBaKey dressing forceps .....	52	McKenty raspatory .....	27, 29		
Endoscopes .....	5 - 7	Medicine cup .....	64, 65		
Endoscope container.....	67	Metal bowl .....	64		
Endoscope protection sleeve.....	8	Metal mallet .....	30		
Ferris-Smith nasal forceps.....	22	Metzenbaum scissors .....	43, 44		
Flexible endoscope.....	9	Micro blades .....	37		
Flexible holding arm.....	14	Micro vascular scissors.....	49		
Fomon alar hook .....	40	Micro Adson forceps.....	51, 52		
Fomon nasal rasp.....	56, 58	Micro handle.....	37		
Fomon nasal scissors .....	47, 48	Micro Ryder needle holder .....	55		
Forceps, anatomical.....	50-53	Miller nasal rasp .....	57		
Forceps, surgical .....	50-53	Mini osteotom.....	33		
Forceps holder.....	65	Nasal forceps.....	20-25		
Frazier suction tubes.....	19	Nasal probe .....	28		
Freer elevator, double ended .....	27	Nasal polyp snares .....	15		
Freer hook.....	40	Neivert needle holder .....	54		
Freer raspatory .....	27, 29	Neivert wire-shaped retractor.....	38		
Freer-Joseph Raspatory, double ended .....	28	Norm sterilisation container .....	66		
Freer septum knife .....	36	Noyes nasal dressing forceps.....	17		



Conversion table – Ch/Fr – mm – inch

Charrière (CH) French (F)	mm	Inch
1	0,33	0,013
2	0,67	0,025
3	1,00	0,039
4	1,33	0,051
5	1,67	0,065
6	2,00	0,079
7	2,33	0,092
8	2,67	0,105
9	3,00	0,118
10	3,33	0,131
11	3,67	0,144
12	4,00	0,156
13	4,33	0,170
14	4,67	0,184
15	5,00	0,197
16	5,33	0,210
17	5,67	0,223
18	6,00	0,237
19	6,33	0,249
20	6,67	0,263
21	7,00	0,276
22	7,33	0,288
23	7,67	0,302
24	8,00	0,315
25	8,33	0,328
26	8,67	0,341
27	9,00	0,354
28	9,33	0,367
29	9,67	0,380
31	10,23	0,407
32	10,67	0,420
34	11,33	0,446
36	12,00	0,472
38	12,67	0,494
40	13,33	0,520
45	15,00	0,591





Größenvergleich der Blätter von Nasenspekula  
Specula blades size comparison

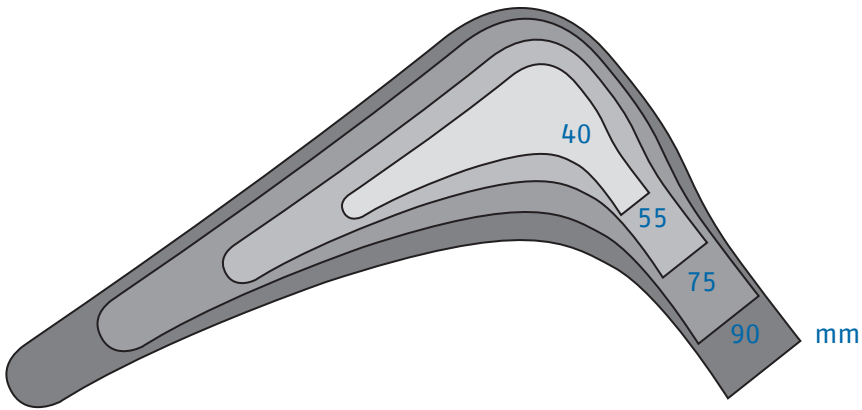







Deutsch



International

Spiggle & Theis Medizintechnik GmbH ist auch über Mobilgeräte wie Smartphones und Tablet-PCs erreichbar – einfach QR-Code scannen!  
Spiggle & Theis Medizintechnik GmbH is also available for mobile devices like smart phones and tablet PC – simply scan QR code!

## SPIGGLE & THEIS

Medizintechnik GmbH

Burghof 14

51491 Overath / Germany

Tel.: +49 (0) 2206 / 90 81 - 0

Fax: +49 (0) 2206 / 90 81 -13

info@spiggle-theis.de

www.spiggle-theis.de

www.spiggle-theis.com

© 2017 by Spiggle & Theis Medizintechnik GmbH

Änderungen und Druckfehler – auch für Bilder – vorbehalten.

Bitte beachten Sie auch, dass ggf. nicht alle Produkte in Ihrem Land vertrieben werden.

Modifications and errors – including pictures – reserved.

Please note also that not all goods might be for sale in your country.